

CAPITAL UNIVERSITY OF SCIENCE AND  
TECHNOLOGY, ISLAMABAD



**Energy-Temperature and  
Mobility Aware Routing in  
WBAN to Deal with  
Disconnection of Bio-Sensors due  
to Postural Mobility**

by

**Amna Haq**

A thesis submitted in partial fulfillment for the  
degree of Master of Science

in the

**Faculty of Computing**

**Department of Computer Science**

2023

Copyright © 2023 by Amna haq

All rights reserved. No part of this thesis may be reproduced, distributed, or transmitted in any form or by any means, including photocopying, recording, or other electronic or mechanical methods, by any information storage and retrieval system without the prior written permission of the author.

*My work is devoted to My Parents, My Teachers, My Family, and My Friends. I have a special feeling of gratitude for My Parents and siblings. Special thanks to my supervisor whose support make me able to reach this milestone.*



## CERTIFICATE OF APPROVAL

### **Energy-Temperature and Mobility Aware Routing in WBAN to Deal with Disconnection of Bio-Sensors due to Postural Mobility**

by

Amna haq

(MCS201012)

### THESIS EXAMINING COMMITTEE

S. No.	Examiner	Name	Organization
(a)	External Examiner	Dr. Yasir Faheen	NUST, Islamabad
(b)	Internal Examiner	Dr. Muhammad Siraj Rathore	CUST, Islamabad
(c)	Supervisor	Dr. Amir Qayyum	CUST, Islamabad

---

Dr. Amir Qayyum

Thesis Supervisor

January, 2023

---

Dr. Abdul Basit Siddiqui  
Head  
Dept. of Computer Science  
January, 2023

---

Dr. M. Abdul Qadir  
Dean  
Faculty of Computing  
January, 2023

## *Author's Declaration*

I, **Amna Haq** hereby state that my MS thesis titled “**Energy-Temperature and Mobility Aware Routing in WBAN to Deal with Disconnection of Bio-Sensors due to Postural Mobility**” is my own work and has not been submitted previously by me for taking any degree from Capital University of Science and Technology, Islamabad or anywhere else in the country/abroad.

At any time if my statement is found to be incorrect even after my graduation, the University has the right to withdraw my MS Degree.

**(Amna Haq)**

Registration No: MCS201012

## *Plagiarism Undertaking*

I solemnly declare that research work presented in this thesis titled “**Energy-Temperature and Mobility Aware Routing in WBAN to Deal with Disconnection of Bio-Sensors due to Postural Mobility**” is solely my research work with no significant contribution from any other person. Small contribution/help wherever taken has been duly acknowledged and that complete thesis has been written by me.

I understand the zero tolerance policy of the HEC and Capital University of Science and Technology towards plagiarism. Therefore, I as an author of the above titled thesis declare that no portion of my thesis has been plagiarized and any material used as reference is properly referred/cited.

I undertake that if I am found guilty of any formal plagiarism in the above titled thesis even after award of MS Degree, the University reserves the right to withdraw/revoke my MS degree and that HEC and the University have the right to publish my name on the HEC/University website on which names of students are placed who submitted plagiarized work.

**(Amna Haq)**

Registration No: MCS201012

## *Acknowledgement*

I praise and worship my Allah who is all in all. He is perfect source of strength in my life. I would like to express my sincerest appreciation to my enthusiastic supervisor, Dr. Amir Qayyum for his supervision, assistance, and immense knowledge. I am sincerely thankful to him for his constant support, motivation, and patience. He has guided me in a very good way. I have learned a lot from him.

I want to show gratitude to my family including parents and siblings for their support and love. They give me a lot of strength. I would not be able to achieve anything without my family.

**(Amna Haq)**

# *Abstract*

Current development and enhancement of Information and Communication Technologies can simplify people's life in different aspect. Health care systems have improved a lot with information and communication technologies. It enables the healthcare provider to monitor, analyze, and prescribe the patients according to their physiological signs. Health care systems are making use of IoT, sensors, edge, cloud, etc. to get accurate and precise readings which can be used to assess and monitor health of patient or person accurately and precisely. Wireless Body Area Networks (WBAN) is a big achievement which is the subfield of Wireless Sensor Network (WSN). It is designed to operate autonomously where various biosensors are embedded in or on the human body which measures the various vital physiological parameters like ECG, glucose level, temperature, etc., and send the data wirelessly to a health monitoring system via a sink node that can be the smartphone for seamless monitoring. When sensor nodes are placed or worn on the body it should not cause any harm to tissues of human body. There are various constraints that affect the performance of WBAN due to limited resources of small sized sensor nodes. An important issue is energy consumption which may lead to the temperature rise of a sensor node, some other issues are limited computation and storage, low power, security of patient's data, topological change with mobility of sensors nodes etc. Our proposed model tackles the dis-connectivity problem caused by the mobility of sensor nodes. The model adapts to topological changes of network while keeping in view the network sustainability in terms of less energy consumption, low temperature, prolonged network life time, decreased packet drop rate, and increased throughput. So in order to provide such balance, we utilize the concept of using dual sink nodes that helps to divide the network load and hence, increase network sustainability. The simulation analysis illustrated that our proposed approach outperforms the two conventional protocols: mobTHE and iM-SIMPLE protocol in terms of energy consumption, WBAN lifetime, throughput, packet drop rate, and temperature control.



# Contents

<b>Author's Declaration</b>	<b>iv</b>
<b>Plagiarism Undertaking</b>	<b>v</b>
<b>Acknowledgement</b>	<b>vi</b>
<b>Abstract</b>	<b>vii</b>
<b>List of Figures</b>	<b>x</b>
<b>List of Tables</b>	<b>xi</b>
<b>Abbreviations</b>	<b>xii</b>
<b>Symbols</b>	<b>xiii</b>
<b>1 Introduction</b>	<b>1</b>
1.1 Wireless Body Area Network . . . . .	1
1.2 WBAN Architecture . . . . .	3
1.3 Types of WBAN Traffic . . . . .	4
1.4 Applications of WBAN . . . . .	5
1.5 Topology of WBAN . . . . .	6
1.6 Challenges in WBAN . . . . .	7
1.7 USE CASE Perspective . . . . .	8
1.7.1 Care Coordinator . . . . .	8
1.7.2 Patient . . . . .	8
1.7.3 USE CASE Scenario . . . . .	8
1.8 Efficient Bandwidth Utilization from Edge to Cloud . . . . .	10
1.9 Problem Statement . . . . .	11
1.10 Research Questions . . . . .	12
1.11 Research Methodology . . . . .	13
1.12 Research Contribution . . . . .	13
1.13 Thesis Organization . . . . .	14
<b>2 Literature Review</b>	<b>15</b>

---

2.1	Introduction . . . . .	15
2.2	Related Work . . . . .	15
2.3	Related Work Analysis . . . . .	25
2.4	Gap in the Literature . . . . .	30
<b>3</b>	<b>Proposed Methodology</b>	<b>33</b>
3.1	Introduction . . . . .	33
3.2	Proposed Architecture . . . . .	33
3.3	System Model . . . . .	36
3.3.1	Sensor Nodes in our Proposed System . . . . .	37
3.3.2	Initialization Phase . . . . .	39
3.3.3	Temperature and Energy Model . . . . .	40
3.3.3.1	Analysis of Sensors' Temperature Parameter . . . . .	40
3.3.3.2	Analysis of Sensors' Energy Parameter . . . . .	41
3.3.3.3	Forwarder Node Selection . . . . .	42
3.3.3.4	Mobility Support . . . . .	42
	Arm Mobility Scenarios . . . . .	43
3.4	Data Transmission . . . . .	53
<b>4</b>	<b>Results and discussion</b>	<b>54</b>
4.1	Introduction . . . . .	54
4.2	Simulation Environment . . . . .	54
4.3	Metrics and Parameters Settings . . . . .	55
4.3.1	Network Topology . . . . .	57
4.3.2	Comparison . . . . .	58
4.3.2.1	Residual Energy . . . . .	58
4.3.2.2	Network Life Time . . . . .	59
4.3.2.3	Temperature . . . . .	60
4.3.2.4	Throughput . . . . .	61
4.3.2.5	Packet Drop Rate . . . . .	63
4.3.3	EDGE Optimization for Efficient Bandwidth Utilization . . . . .	64
4.3.3.1	Proposed Methodology . . . . .	64
4.4	Performance Results . . . . .	67
<b>5</b>	<b>Conclusion and Future Work</b>	<b>68</b>
5.1	Conclusion . . . . .	68
5.2	Future Work . . . . .	70
	<b>Bibliography</b>	<b>71</b>

# List of Figures

1.1	Architecture diagram . . . . .	4
3.1	An Architecture of our Proposed Work . . . . .	34
3.2	Work flow diagram of our proposed system . . . . .	35
3.3	Sensor deployment of proposed system . . . . .	37
3.4	Initialization phase of proposed system . . . . .	39
3.5	Scenario 1 of proposed system . . . . .	44
3.6	Scenario 2 of proposed system . . . . .	46
3.7	Scenario 3 of proposed system . . . . .	47
3.8	Scenario 4 of proposed system . . . . .	49
3.9	Scenario 5 of proposed system . . . . .	50
3.10	Scenario 6 of proposed system . . . . .	52
4.1	Topological diagram of our proposed system . . . . .	57
4.2	Comparison of residual energy with iM-SIMPLE protocol . . . . .	59
4.3	Comparison of Network life time with mobTHE protocol and iM-SIMPLE . . . . .	60
4.4	Comparison of temperature with mobTHE protocol . . . . .	61
4.5	Comparison of throughput with iM-SIMPLE protocol . . . . .	62
4.6	Comparison of throughput with iM-SIMPLE protocol . . . . .	62
4.7	Comparison of Packet drop with iM-SIMPLE protocol . . . . .	63
4.8	Flow chart for reducing bandwidth from edge to cloud . . . . .	65
4.9	Comparison between Filtered and Non-Filtered data from egde to cloud . . . . .	67

# List of Tables

1.1	Comparison of different wireless networks . . . . .	5
1.2	Research Contribution . . . . .	14
2.1	Strengths, Weaknesses, and Objectives of Protocol . . . . .	26
2.2	Depicts the Summary of Related Work . . . . .	32
3.1	Best, average and worst case for scenario 1 . . . . .	45
3.2	Best, average and worst case for scenario 2 . . . . .	47
3.3	Best, average and worst case for scenario 3 . . . . .	48
3.4	Best, average and worst case for scenario 4 . . . . .	50
3.5	Best, average and worst case for scenario 5 . . . . .	51
3.6	Best, average and worst case for scenario 6 . . . . .	53
4.1	Simulation parameters . . . . .	56
4.2	Description of data rates of sensor nodes . . . . .	56
4.3	Description of positions of sensor nodes . . . . .	57
4.4	Normal and threshold values of different sensors . . . . .	66
4.5	Description of flags assigned to sensor nodes . . . . .	66
4.6	Comparative Results . . . . .	67

# Abbreviations

<b>AP</b>	Access point
<b>BER</b>	Bit Error Rate
<b>BP</b>	Blood Pressure
<b>CM</b>	Cluster Member
<b>CH</b>	Cluster Head
<b>CN</b>	Coordinator Node
<b>CF</b>	Cost Factor
<b>ECG</b>	Electrocardiogram
<b>EEG</b>	Electroencephalogram
<b>FN</b>	Forwarder Node
<b>ICT</b>	Information and Communication Technologies
<b>IoT</b>	Internet of things
<b>IP</b>	Internet Protocol
<b>NS3</b>	Network Simulator Version 3
<b>QoS</b>	Quality of Service
<b>RF</b>	Radio Frequency
<b>SAR</b>	Specific Absorption Rate
<b>S1 to S13</b>	Sensor Node 1 to Sensor Node 13
<b>SN</b>	Sink Node
<b>SpO<sub>2</sub></b>	Oxygen saturation
<b>WBAN</b>	Wireless Body Area Network
<b>WHO</b>	World Health Organization
<b>WSN</b>	Wireless Sensor Network

# Symbols

$T_{emp}$	Temperature
$thr_{Temp}$	Threshold Temperature
$E_{rx}$	Energy consumed by receiving k-bits of data
$E_{tx}$	Energy consumed by sending k-bits to node
$k$	Bits of Data
$E_{elec}$	Energy consumed by circuit while sending and receiving
$E_{amp}$	Energy consumed by power amplifier while sending data
$E_i^{res}$	Residual Energy
$E_i^{con}$	Consumed Energy
$E_i^{initial}$	Initial Energy

# Chapter 1

## Introduction

### 1.1 Wireless Body Area Network

Now a day's health is primary concern for every person and due to the growth in the elderly population, polluted environment, and unhygienic food health issues are increasing day by day so people need to pay more attention to their health conditions. Also, WHO statistics show that about "17.5 million" people die due to enduring diseases each year like cardiovascular, cerebrovascular, and diabetes. This number is probable to reach nearly 629 Million by 2045[1]. Therefore, it is required to have a inclusive and first-class health care system to benefit so, in order to improve the situation and provide continuous health monitoring, smart health care has grown and its advantages like flexibility, simplicity of observing, and mobility of the patient which causes reduction of hospital cost, as well as work load of medical professionals, results in higher efficiency. It also makes use of the modern technologies like edge and cloud computing, IoT, and big data processing.

Nowadays, wireless communication is growing rapidly as an emerging technology and its most vibrant and important feature is mobility which allows a person to move spontaneously while still associated to the network. Wireless networks is being used in numerous applications such as education, the industrial sector, tracking device, tracking the appliances, health care, etc.

WBAN-Wireless Body Area Network is the main applications of WSN-Wireless Sensor Network that consists of biomedical sensors abbreviated as nodes positioned internal or external part of the human body to ensure continuous observation of crucial signs of a patient which in turn helps in early diagnosis of diseases without disturbing daily routine and it operates with a restricted transmission range of up to “1-2 meters”. These nodes cooperate with each other in order to perform efficient health monitoring, its applications are in areas of remote health monitoring, athlete monitoring, soldier surveillance, advanced animal, etc [2]. In the medical field, for example, it provides distant handling of patient and supports to abolish the distance hurdles which also advances health access to countryside populations. Each sensor node performs its function like monitoring heartbeat, blood pressure, glucose level, respiration, temperature, etc. The main drawback of these small-sized sensors is their limited resources like low power battery, thermal sensitivity, energy constraints, etc. The sensor devices called nodes deployed/implanted inside or outside the body, have sensing units that sense various human physiological parameters in order to monitor any abnormal or critical conditions in the human body[3].

There are two categories of communication in WBAN i.e. communication of different coordinator/sink nodes located on two or more bodies and communication among sensor nodes within a body called Inter-WBAN and Intra-WBAN respectively [4]. In intra-WBAN, the sensor nodes communicate with each other having a transmission range of 2m approximately. The sensor nodes transmit the physiological signals to the coordinator or sink node and point-to-point connections are established among sensor nodes for communication between sensor to sensor and sensor to the coordinator node. While Inter-WBAN is the communication between the coordinator node and various access points. Access points are used to assist the sensor node to communicate further like communication between the coordinator node and edge node which can be Raspberry PI.

The coordinator node sends processed and aggregated data toward the access point. WBANs can be connected in different networks for easy access on daily basis. Zigbee can be used for this type of communication. There is another



type of communication whose scope is beyond WBAN. This communication is between WBAN and Internet. Coordinator nodes and the access point can directly communicate with the outside networks i.e. Internet. AP aggregates all data and transmits it to doctors or physicians who can easily be informed about any emergency case.

## 1.2 WBAN Architecture

WBAN architecture is demonstrated in figure 1.1 in which architecture consists of different sections i.e. WBAN consists of multiple sensors deployed strategically on the human body which continuously measure different psychological signs. These nodes are low-power and cheap. These nodes are being used for constant observation of vital signs like temperature, ECG, BP, heart-rate, etc. also monitor body movement and surrounding environment. BAN can be wired but that is problematic as it could restrict the mobility of the person. So, WBAN is a very effective solution especially in the health care system with mobility support.

Next are the coordinator and sensor nodes in WBAN where sensor node forwards the acquired data to the sink node which is a considerably large storage and high power node, which collects data and then sends data to the next section [5].

The third section is the gateway or base station which transmits data to the Raspberry PI where some processing will take place for efficient utilization of bandwidth. Data from the edge device will be transmitted to a cloud server where data can be used for long-term interference and its results will be given to patients or doctors via mobile application.

At end-user applications, doctors can view patient records and can take quick judgements based on the criticality of the data. The mobile application makes it easy to get timely information and alert message.

Sensor nodes need to satisfy the following requirements i.e. continuous examination, small and lightweight as the battery's capacity is directly proportional to

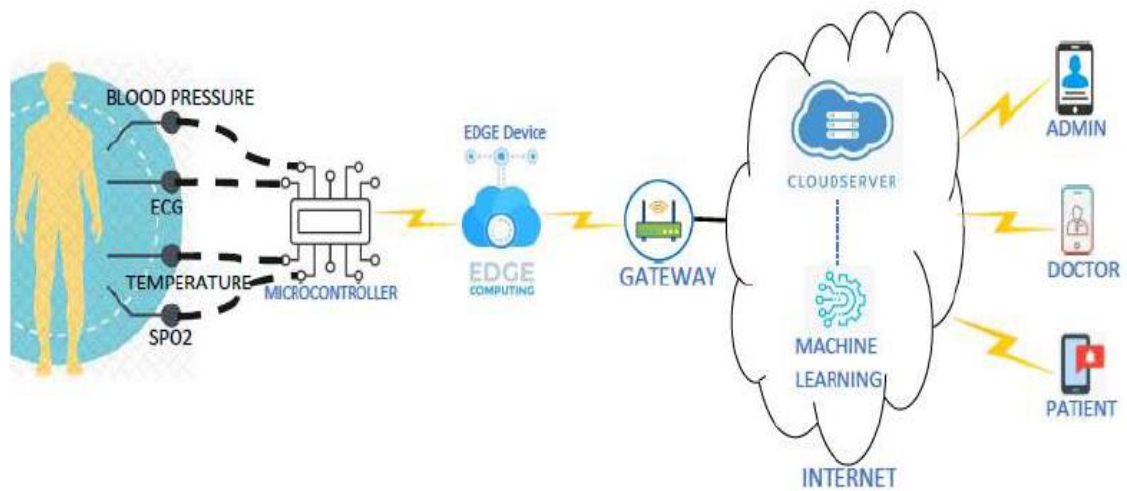

FIGURE 1.1: Architecture diagram

its size. When sensor nodes meet the requirements mentioned, it will be an efficient system that measures the physiological parameters of a human being in a timely manner. While, also need to keep in view the limitations and constraints of sensor nodes.

### 1.3 Types of WBAN Traffic

In WBAN, network traffic or data is mainly divided into three categories i.e. normal data, emergency or critical data, and on-demand traffic. Normal data is the traffic that monitors normal readings without any emergency or on-demand. Critical data traffic is when physiological measurements exceed some predefined threshold. On-demand traffic means the traffic which is initiated by some authorized person like a doctor in order to investigate the history of a patient for further analysis.

#### Communication Technologies used in WBAN

There are different communication technologies involved at different stages like "Bluetooth", "Zigbee", "WIFI", "IEEE 802.15.6", etc. Bluetooth typically consumes less energy as it is a short-range wireless communication. It works in the form of master-slaves, called pico-net where there are seven slaves connected to

one master. There is another network of Bluetooth, called scatternet where a node can act as master or slave in different piconets. It operates in a “2.4 GHz ISM” band with a transmission range of “1mW to 100mW” with a “3Mbps” data rate [6] and all devices can communicate in NLOS conditions.

Zigbee is designed for sensors and controls, mostly appropriate for severe and remote conditions with low power consumption. It can operate in different frequencies of 868MHz, 915 MHz, and 2.4 MHz and range between 50 to 70m [7]. IEEE 802.15.6 supports communication inside or around the human body such as in e-health monitoring and sports. It supports different frequency bands of 400 MHz, 800 MHz, 900 MHz, 2.3GHz, and 2.4GHz.

Table 1.1 [8] shows the comparison of various wireless networks.

TABLE 1.1: Comparison of different wireless networks

Specifications	Bluetooth	WiFi	Zigbee
IEEE standard	802.15.01	802.11b/g	802.15.04
No. of connected devices	7	32	Upto 65,000
Bit rate	720 kb/s	11/54 Mb/s	20-250 kb/s
Range	10m	100m	100m
Battery life	1-7 days	1-5 days	100-1000 days

Sensor nodes are categorized as “invasive” and “non-invasive” i.e. implanted on the human body and wearable respectively. “Non-invasive” sensors are used to observe SpO<sub>2</sub>, blood pressure, electroencephalogram (EEG), Temperature, electrocardiogram (ECG), etc. while “invasive” are used in cases like intractable epilepsy, Parkinson’s disease, and chronic pain. Our focus is non-invasive ones.

## 1.4 Applications of WBAN

Wireless Body Area Networks are capable of transferring voice, pictures, videos, data, etc. through wireless communication path. Due to which there are abundant advanced and effective applications. In the case of medical applications, there

is remote health monitoring which offers medical service through remote monitoring of vital physiological signs of patients. Sensors can be in-body or on-body implants. All information is monitored, stored, and transmitted via the control unit/coordinator remotely.

Another type of medical application provides distant health care services with the help of ICT-”Information and Communication Technology” called telemedicine. WBAN is also incorporated in transmission of remote medical diagnoses, medical reports and images that it provides online video consultation with doctors. Patient’s condition can be monitored from anywhere where doctors can provide e-prescriptions. While in non-medical applications, it is used in sports to measure the biological activities of the wearer like navigation, timer, distance, BP, posture, etc.

It can also be used in military where it can be used for communication among militaries and base commanders to send their goings-on like attacking, retreating, running, etc. and to monitor location, health condition, hydration level, etc. So, it provides more survivability, connectivity, accuracy, etc.

WBAN also plays important role in our routine life like navigation support like driving, walking, exploring new places, etc. Also, assist in monitoring infant movement, making video calls using a big screen, etc.

## 1.5 Topology of WBAN

WBAN topology can be a single-hop star or multi-hop star depending on the scenario. Mobility of body causes a immediate change in topology which is very complicated issue causes fading effects that lead to channel impairments that increase the bit error rate (BER) [9] resulting in unreliable data transmission.

Moreover, precarious data transmission may also get delayed which is not acceptable. Topological changes may also cause packet loss which increases power consumption.

## 1.6 Challenges in WBAN

WBAN is characterized by its heterogeneity like variations in the task, sampling, required resources, sizes, level of intelligence, etc. There are many technical challenges associated with the connectivity of sensor nodes like mobility, routing, security, energy, fault-tolerant, interference management, reliability, etc. Sensor nodes in WBAN are portable and free to move as most of the devices are wireless. As it's mentioned, these are small-size battery operated, so power is always limited and the battery cannot sustain more than a month. Communication bandwidth and processing power affect power consumption and it's not feasible to re-install implanted sensors as it is always troublesome or even impossible.

Hence, there is a need to have better power management schemes for efficient utilization of the power of sensor nodes which prevents quick energy or power depletion of nodes. Another important thing to be considered for the transmission of medical data is the quality of service (QoS) as requested by the user. Timelines may be the critical parameter for life-critical systems. Similarly, the end-to-end wireless connection between the sensor and sink nodes or seamless roaming is another QoS requirement. Mobility is defined as a seamless link between the user and WBAN. Due to mobility one of the issues arises that is how to reach the sink node which can be located at a single or multi-hop distance. There are multiple solutions suggested by researchers like message flooding to all nodes and the path with minimum delay is selected etc. Another important issue is the selection of intermediate nodes between source and destination, it provides aid for many limitations of WBAN such as mobility, channel impairment, coverage, or distance. However, it may lead to additional overhead. Also, as the network grows, affects the performance and throughput of the network's routing protocols. There are also security risks related to WBAN. The physiological information of patients is secretive and alterations in such information may cause serious alarm for the patient as it may be the matter of life and death for a patient. Hence, the transmission of such information between sensors, sensor to coordinator node, and further transmission needs to be secure.

## 1.7 USE CASE Perspective

The use case focuses on the exchange of physiological data between patient monitoring devices and doctors. The use case will describe remote monitoring from two aspects and these aspects are representative of roles and functions instead of physical location or organization.

### 1.7.1 Care Coordinator

It includes clinically-trained physicians, nurses, doctors, or other clinical personnel. They help patients in following their care plan and take immediate action or intervene immediately if some emergency case is found i.e. if some critical data is sensed by patient monitoring devices that measurement falls outside of the pre-defined threshold or if a potential health issue is indicated.

### 1.7.2 Patient

It includes patient family, surrogates, caregivers, patient itself and other parties who are in concern or support patient. Monitoring devices implanted on human body sense data and take relevant action based on criticality of the data. The sensed data is then transmitted to the coordinator/sink node which in turn transmit the data to Raspberry PI. Raspberry PI perform relevant processing on data like extracting feature or checking the for emergency case and then performing relevant action, either forward data immediately toward cloud or sends data periodically in order to save bandwidth by avoiding transmission of redundant or non-critical data

### 1.7.3 USE CASE Scenario

In this area, when choosing the appropriate WBAN, connectivity of the sensor nodes along with concern of energy, temperature, mobility are very major features

to be considered because these factors affect the performance of WBAN. Various research work have center of attention on medical purpose of WBAN.

The objective of our work is to recognize and choose current techniques and protocols which satisfies the major prerequisites of WBAN in healthcare with respect to energy consumption, mobility of postures, reliable, secure data, and the requirements need for lots of sensor nodes to coincide in a relative small space. Since, important issue of WBAN is limited resources so for the relevant application of WBAN i.e. designing energy and temperature efficient routing protocol is challenging task.

In the meantime, the mobility of human body's posture is another challenge, that changes the position of sensor nodes which may cause dis-connectivity of sensor nodes and coordinator node, for that reason, the packet drop-rate can increase. Consequently, in order to perform efficient routing, it is required in WBAN to meet critical operational requirements such as energy efficiency, characteristics of the body, network lifetime and postural change control[10].

During processing and communication, it is very important to design a routing algorithm in proper manner to overcome supplementary energy overhead like issues related to energy efficiency.

In the design of network layer, the main challenge [11] includes less delay, high accuracy of received data, high throughput, a high packet delivery ratio, efficient bandwidth utilization and synchronization of wireless technology.

When any sensor node get disconnect due to mobility then it will choose some other sensor node as forwarder node which act as intermediary between source and destination.

When data needs to be transmitted from source node, then it will look for some neighbor node which can forward its data to the sink. The forwarder node can be chosen based on its temperature, energy, and hop count. The node with maximum remaining energy, minimum temperature, and minimum hop count is selected as forwarder node. This process goes on until the source packet reaches its destination. From WBAN, data is then transmitted to edge where some initial

pre-processing takes place and then data is transmitted to cloud where doctors, patient and admin can access the data.

## 1.8 Efficient Bandwidth Utilization from Edge to Cloud

IoT connects plenty of heterogeneous types of devices and characteristics using interrelated network, it allows sensor nodes to interconnect in most diverse possible domains, therefore it offers significant prospective to produce instincts over the data which travels through the network. Hence, from the last decade it is receiving much attention from industry and academy.

Furthermore, when things get connected to a network domain it increases the data growth and amount of data produced, processed, and stored from several sensors and distributed data sources lead to increase in data enormously. However, the constant increase in data generation imposes challenges for consuming and providing the data. Consequently, in order to manage such big data efficiently, to increase resource consumption, and to save money, data preprocessing and reduction are the promising conceptions.

Edge computing principles were presented in 60s however, researcher presented network solution [12] of web congestion problem in 1990s. The efficient solution to deal with above mentioned issues of big data the concept of edge computing has emerged to support such activities.

Edge handles the data at a point that is closer where data is generated before sending to the cloud. It improves the effectiveness of data, lessens bottlenecks on cloud by pre-processing the data. Moreover, it avoids unnecessary transmission of data along the network.

Usually, edge is placed between data source and cloud via intelligent hardware technologies like Servers, routers, and gateways used as edge. However, any hardware with nominal storage and processing can be used as edge. When dealing with



sensor's data, the idea of applying data reduction approaches carries many advantages. There are numerous data lessening techniques that can be used in three stages. There are many challenges concerning data management are enacted by heterogeneous IoT sensors due to increase in data production. IoT paradigm cooperate to this data in a variety of ways. The problem of transmitting yottabytes of varied IoT sensor's data without data reduction can cause system bottlenecks. By applying data reduction techniques we can avoid network bottlenecks and can send the useful and relevant data to the upper-layer applications.

This process shrinks void data and by using different approaches and techniques data can be converted to simplified, and correct ordered. The purpose of this study is to demonstration some tangible solution for reducing data of different physiological sensors at the edge in order to save bandwidth and various bottlenecks at cloud.

Data preprocessing is vital because the real-life data is noisy, unreliable, and partial which can lead to poor data quality that results into low quality data models built on data. Data pre-processing helps to organize the data into meaningful form that helps for better understanding of data.

There are primarily four methods of data pre-processing i.e. "data integration", "data cleaning", "data transformation", and "data reduction Our focus will be on data reduction techniques in order to efficiently utilizing the bandwidth.

## 1.9 Problem Statement

Some of the major concerns in WBAN are (a) Continuous connectivity and (b) Efficient bandwidth utilization for transmission of real time data. Existing literature has defined different types of techniques to enhance the performance of WBAN in terms of managing energy and temperature limitations of sensor nodes. But very few researches addressed both of the issues to ensure connectivity of sensor nodes and to provide mobility of sensor nodes.

## 1.10 Research Questions

Based on problem described above we have identified following research questions:

**RQ1** What are the different routing techniques used in WBAN for efficient utilization of resources?

There are different routing protocol proposed by the researchers by keeping in view the various limitation of WBAN like limited battery power, small size, thermal sensitivity, and energy constraints etc.

**RQ2** How existing routing techniques can be enhanced so that most optimal path can be preferred?

We considered the thermal and energy based protocols. After studying various techniques we adressed thermal, energy constraints of sensor nodes. Feature of mobility is also introduced.

**RQ3** How alternate path is chosen in case of minimum residual energy and high temperature of the forwarder node?

For best optimal path toward sink, we considered the maximum remaining residual energy and minimum temperature for choosing the forwarder node hop-by-hop to reach the destination called sink or coordinator node.

**RQ4** How the data transmits if sensor nodes get disconnected to the sink or coordinator node due to postural movement?

Our approach focuses on multi-objective routing in which different constraints of WBAN is considered, we mainly focused on mobility of the sensor nodes which causes dis-connectivity to the sink node due to postural movement.

For this, we use the best, average and worst cases based on the distances between sensor nodes. The distance between the sensor nodes directly affects the energy consumption i.e. distance between sensor nodes is directly propotional to energy consumption.

**RQ5** How can we reduce the traffic load from edge to cloud by reducing the data at the edge?

Our mechanism is bit simple which look for redundant, unchanged, and non-critical data to be transmitted. It limits the data transmission by avoiding unnecessary

transmissions at edge which will be transmitted periodically whereas the critical data is forwarded immediately. We need to focus that which sort of data from physiological sensors is critical and non-critical.

## 1.11 Research Methodology

- 1.) In the first phase, we did literature review where our focus was on the forming clusters in WBAN which support better connectivity of WBAN. But later on, we move our concern towards connection of coordinator node to edge node but, we didn't find any valid related literature review.
- 2.) In second phase, we again shifted our concern back to connectivity of sensor nodes to coordinator or sink node. We worked to find some common routing techniques that are relevant for connectivity of sensor nodes in WBAN. After studying various routing algorithms, we find out that existing techniques focuses on different limitations of WBAN like energy, temperature, and mobility individually.
- 3.) In order to overcome the gap in existing techniques, we moved our concern in providing such routing algorithm which is multi-objective i.e. focuses on Energy, temperature, hop count and mobility of sensors nodes which causes dis-connectivity due to postural movements.
- 4.) WBAN application is implemented after studying detailed documentation of WBAN.
- 5.) Steps performed in our algorithmic approach are discussed below briefly.

## 1.12 Research Contribution

In this research work, we have proposed a technique of implementing routing algorithm in Intra-WBAN which handles dis-connectivity problem due to postural movement. The routing mechanism also handles the issue of temperature rise, quick energy depletion by providing most optimal path to the sink node. It also deploys two sink nodes in order to distribute the work-load of network which helps

in increasing the network life time, more energy efficient, and more reliable in terms of network stability. Parameters have also formulated for suitable selection of forwarder node in case of disconnection i.e. minimum temperature, minimum hop count, maximum energy, minimum load and minimum hop count. By this process, traffic is forwarder to the node with the most strongest parameteric values. In case no appropriate node is found, backward forwarding mechanism is used. We have compared our proposed technique on the basis of some metrices given in chapter 4 section 4.3 and improvment is shown in table 1.2 below:

TABLE 1.2: Research Contribution

Sr no.	Metrices	mobTHE	im-SIMPLE
1.	Residual Energy	41.3%	58.7%
2.	Network Life time	7.9%	33.5%
3.	Temperature Rise	23.62%	—
4.	Throughput	17.3%	63.2%
5.	Packet drop rate	—	12.1%

## 1.13 Thesis Organization

The format of this thesis is as follows:

- After introduction chapter, literature review is given in chapter 2.
- Proposed methodology is given in chapter3.
- Evaluation, implementation, and results of the proposed approach is presented in chapter 4.
- Entire work is summarized in conclusion and gives future research directions in chapter 5.

# Chapter 2

## Literature Review

### 2.1 Introduction

This section provides a comprehensive literature review of the research conduct in this area and provides critical reviews of all the proposed approaches.

For understanding the background of thesis, it is significant to understand Wireless Body Area Network paradigm in better way. The main purpose of this section is to consider the available literature relating to Wireless Body Area Networks and how this approach is facilitates remote patient monitoring which also considers various limitation of WBAN while designing it.

We have divided this chapter into three sections: Section 2.1: Shows the related work, Section 2.2: Shows the analysis of related work.

### 2.2 Related Work

Topical advancement in micro-electromechanical system have opened up great scope for application of smart environment. Exclusively in health-care system, sensors implanted on or around body to estimate divergent types of crucial signs like motion, temperature, heartbeat, etc. Thus, designing innovative services to

improve health care. In this field, several researches have been done and also many problems may arise during the communication of sensor nodes. We mostly studied architectures of different wireless body area network, routing protocols based on various challenges faced by network of IOT.

In [11], a fully-passive RFID system, named NIGHT-care, is developed where wearable and ambient tags are combined for observing the state of elderly and disabled people during the night that recognizes any anomalous events which involves instantaneous by estimating various sleep parameters, categorize human activity, etc.

In [13], mHealth is developed that is one of the frameworks developed and deployed. It has three-layer architecture i.e., Data collection layer that are able to sense and collect health specific parameters via IoT devices. Data storage layer comprise of storing the health data on high speed racks at large scale. Data processing layer comprises of investigating these sensor's data using numerous procedures that involves both AI and non-AI algorithms. The communication technologies like ANT, WiFi, Zigbee, Bluetooth Low Energy, or Near-Field Communication (NFC) communication protocol can be used.

In [14], IEEE 11073 standard is presented for individual's health and health devices like for movement monitors, medication dispensers, glucose level monitors, etc. Its architecture make use of CoAP protocol by improving it i.e. layer of IEEE 11073 protocol was added. It uses Datagram Transport Layer Security (DTLS).

In [15], geographical positions of nodes is used and it provides improved clustering-based mechanism for proficient routing of traffic in multi-hop situation.

[16] Proposed an HIOT architecture which involves end processing module, Edge control module and cloud management module and introduces intelligence in order to provide efficient data processing on. Intelligence level in this scheme performs better than traditional methods.

[17] discussed the overview of 6G enabled technologies and massive IOT due to energy challenges in fog computing. There are many routing technique based

on meta-heuristic approach and considering various challenges of IOT like rise in temperature, energy-efficiency, topological changes, QoS etc.

In [18], Proposed QoS-enabled routing protocol inspired by foraging behavior of whales i.e. "Whale Optimization Routing Protocol (WORP)", "Particle Swarm Optimization, (PSO)", "Grey Wolf Optimization (GWO)", "Ant Lion Optimization (ALO)" and many variants of these. One of the main problems in WBAN is temperature effect on sensor nodes which restrain nodes from communicating.

[? ] In intra-WBAN routing different thermal aware routing protocol has been proposed like for preventing hotspot node in wireless body are network to enhance network life-time and performance.

In [19], Ullah et al. proposed an "Energy-efficient Harvested-Aware clustering and cooperative Routing Protocol for WBAN (E-HARP)" for minimum consumption of energy. In order to select a cluster Head, various parameters are used like residual energy, SNR, transmission power. CH is selected in each round for efficient distribution of load. Concept of cooperative effort is used in order to save energy consumption by avoiding transmission of redundant packets. E-HARP shows enhancement as compared to existing protocols in terms of network life-time, throughput, delay, packet delivery ration, and network stability.

In [10], Saleem et al. presented a protocol to handle the seamless communication in case of dis-connectivity by keeping in view the throughput, network life-time, network sustainability, and temperature. Here two sink nodes are utilized and in order to provide seamless communication handoff mechanism is used to avoid redundancy and to synchronize two sink nodes that leads to reduced packet loss. The protocol shows better results as compared to THE protocol and iM-SIMPLE protocol.

In [20], Smita et al. proposed a modified version of ATTEMPT protocol which constructs cost function for the selection of next hop that is calculated using residual energy, rate of sending data, and distance among nodes. Therefore, this approach satisfies the efficient energy consumption and low delay.

In [21], Su et. al. proposed enhanced temperature aware routing protocol which also supports mobility and this protocol considers three parameters for routing: temperature, link quality, and hop-count for selection of next-hop but energy consumption of node is not considered.

In [22], Ghufran et al. proposed a thermal and energy aware routing protocol and make a cost factor based on three metrics: link quality, heat dissipation, and energy consumption for selection of best next-hop. In [23], Mu et al. proposed a Simplified Energy-Balance Alternative-Aware routing in which current load of the sensor node and residual energy of the sensor are considered for routing and transmitting data to sink node. SEAR is fault tolerant i.e. recognizes either connections between nodes are interrupted or nodes are void and swiftly fixes connection by accumulating the connection field to the routing table. It lessens energy depletion and end-to-end delay and increases network throughput. However, it do not consider the temperature of node for the selection of forwarder node .

In [24], Chen et al. proposed "power aware 2-cover path routing" algorithms i.e. Graph Transformation Planning (GTS), Radii Shrink Planning (RSP), and 2-covered area stretching planning (TASP) which performs discrete transmission with power levels and variable ranges. The results shows that it achieves 96 % of power saving and improves network life time. Though, due to presence of redundant nodes, simulation period of this methodology is considerably higher.

In [25], Abidi et al. proposed energy-efficient clustering based routing protocol which utilized clustering, gateway body sensor, and data aggregation to minimize energy consumption. This approach increases network life time and network stability.

In [26], Bidgoli et. al. proposed "Evolutionary Based Multi-hop routing algorithm" to resolve the concerns of least optimum route selection and manual controlling. It articulates multi objective cost function that includes distance, path loss, energy level, energy consumption and uses Genetic algorithm for selection of forwarder node. It shows better results in with minimum energy consumption, path loss and maximum throughput and network life time.



In [27], Yang et. al. proposed energy efficient protocol which take into account the difficulty of replacing sensors on human body. Simulation and findings shows that it greatly increases network life time. In [28], Karmarkar et al. proposed enhanced routing protocol i.e. MHRP which is explicitly designed for attainment of heart rate. It recommends fault-tolerant context which comprise of two distinct and similar node set, where seven sensor-nodes are placed on human body.

In [29], Samanta et. al. proposed efficient and distributed routing- NCMD, it is represented that Wireless Body Area Network is dynamic which causes increases network maintenance cost and also great transmission delay.

In [30], Anirban et al. presented "Hotspot Preventing Routing (HPR)" that is an enhancement of LTR and ALTR i.e. HPR avoids the formation of hotspot while in LTR and ALTR hotspot node is not prevented by decreasing the average network temperature. HPR reduces the average network delay by preventing the packets from taking suboptimal paths. This algorithm uses threshold value and shortest hop method in order to reduce delays and preventing hotspots. It involves two phases i.e. initialization phase and routing phase. In the initialization phase, sensor nodes construct a routing table by communicating the statistics about the shortest path to destination and initial temperature. In the second phase, the shortest hop method is used where it is checked that no hotspot come into view in the pathway. By the use of average threshold value which is derived from the neighbor node's average temperature and the source node's temperature, a hotspot is dynamically determined.

The packet will be transmitted to the "coolest" neighbor. It also uses the mechanism of MAX HOP introduced in LTR in order to avoid routing loops which drops the packet when threshold value reaches. In this protocol, threshold value for hotspot detection is dynamically defined by considering the neighbors temperature and sources' temperature due to which it is different from its precursors where threshold value is pre-defined.

In [31], Takahashi et al. presented "Least Total Route Temperature Routing (LTRT)" which is the hybrid version of LTR protocol and shortest hop routing

algorithm is thermal aware routing and selects the route with the minimal temperature. First, it constructs all conceivable paths to the destination by collecting temperature information of all neighboring nodes. Then, it builds weight graph by assigning temperature to each intermediate node, the graph is build using “Dijkstra’s algorithm” in order to figure out the problem of single source shortest path. The path having lowest temperature is selected. In spite of association between two directly linked nodes.

LTRT handles the end-to-end connection perspective and from all possible routes select the least temperature route.

In [32], Kauret al. presented a DSDV routing protocol is proposed based on AODV and DSR-based routing. This scheme showed poor performance as compared to other existing techniques.

It shows high packet loss rate i.e. almost equal to 90% that also creates high routing overhead DSDV eliminates the base station due to which bottleneck is formed for transmission of data between base station and access point results in communication blockage and data loss among layer 3 and 4.

In [33], Tabandeh et al. presented ”Thermal-aware Shortest Hop Routing (TSHR)” that is an enhancement over HPR. It is relatively alike to HPR in a way that it has two parts i.e. initialization phase and routing phase and it also uses the concept of a threshold value. However, in TSHR two kinds of thresholds are described i.e. dynamic and fixed threshold. Dynamic threshold value is interpreted contingent on each node where temperature of neighbor node and its own is considered, whereas a fixed threshold value is predefined and applies on all nodes. Hotspot node is determined on the basis of dynamic threshold and source node will look for a node with least temperature that has not been visited by packet. On the contrary, in case of fixed threshold, whenever a node want to transmit a packet, this value is considered each time.

The packet is stored till the next hop cools down or its temperature goes below defined threshold if it reaches the defined value by comparing the temperature of

next hop to the threshold value. Here, the packet is not dropped, if the threshold defined for maximum hop value reaches instead packet is transmitted using shortest hop algorithm.

In [34], Bassiouni et al. presented temperature and power aware routing protocol which intends to reduce the average power consumption and average temperature rise of sensor nodes. It has three stages that are: setup, routing and status update phase. It uses the transient IDs that are arbitrarily created rather than using static global IDs. One ID is reserved i.e. ID “zero” for sink node. In setup phase, all nodes broadcast their IDs via hello message. In the second phase, each data packet is routed towards destination nodes via multi-hop technique and every data packet is having a exclusive packet ID. In order to avoid loops in a network, hop count is coupled with every data packet. For this purpose, a variable is defined called HOP-THRESH, and data packet is rejected if the value of hop count surpasses the defined threshold value. Each sensor also maintains list of data packets IDs in order to avoid the transmission of duplicate data packets which is dropped. Estimated temperature of neighbor nodes is maintained by every node through observing their communication. If the destination is not in neighbors then it is forwarded using relay node via likelihood which is contrariwise to its temperature, otherwise it is directly forwarded to destination. In third phase, in order to reduce power consumption, the sink informs its entire neighbor nodes by sending packet’s ID of received data packet.

In [35], Alrajeh et al. presented energy aware and temperature aware routing protocol for reducing temperature of a node and to reduce the delay for the serious data. In the network, sink is positioned at the middle while other sensors that are having high data rates are positioned at less movable parts of the human body. The sensor nodes strengthen their communication power in order to transmit crucial or query driven packets and direct those packets straight to the sink node i.e. single hop communication whereas multi hop communication for delivery of normal packet. In case of multi-hop communication, if two or more routes are available for delivering data to sink then the path with fewer hop-count is chosen. If several neighbor nodes having the equal number of hop count then the node

having less consumption of energy to the sink is chosen. M-ATTEMPT defines threshold for controlling the temperature rise and it disrupts all the paths with the node if temperature of any neighbor node exceeds the threshold. Conversely, if after receiving data packet, temperature of a node reaches to the threshold, packet is resend to preceding node and that node mark it as hotspot. It contains four stages i.e. initialization, routing, scheduling, and data transmission phase. In first phase, hello packet is broadcasted by all nodes. In second phase, the path having minimum hop-count to the destination or sink will be picked within the presented routes based on aforesaid method. In the third stage, Time Division Multiple Access (TDMA) schedule is followed by all root nodes. In the transmission phase, the data is transmitted from root nodes towards sink node.

In [36], Nadeem et al. presented the improved form of SIMPLE routing protocol by taking into consideration mobility and mathematical models concerning to increase energy efficient routing and reliability for Wireless Body Area Networks. In initialization stage, sink broadcast a message which includes its position on the body and all other nodes broadcast its location, energy and ID. In this way, the information of sink node and their neighbors reaches to all nodes in the network. Moreover, for minimizing the consumption of energy a WBAN network, a cost function is introduced that defines two parameters for the selection of next hop and those two parameters are residual energy and distance. In the scheduling and data transmission phase, TDMA slots are assigned to forwarder node and all other nodes by the sink. For mobility support, only arms mobility in two positions is considered where a moving node connects wirelessly to the neighbor node. This technique showed improvement in throughput and network stability of Wireless Body Area Network.

In [37], I. Moerman et al. proposed an energy efficient cross-layer protocol which covers both routing and MAC layer. It make use of spanning tree data structure to send data packet to the sink that assured collision-free medium access, prevention of idle listening and, low interference. Sequence of cycle defines data transfer. Each round is distributed into a data and control round and each sub-round has its own pattern for slot allotment. In control sub-round, parents allot

the control and data schemes to their children where children are granted with their transmission slots. One slot is assigned to every node. When a children node obtains its packet in the allotted slot from its parent, it goes to sleep as in that particular slot, after that packets will no longer incoming. After that, node comes in active state only whenever it needs to transmit its scheme to its children. In data Sub-cycle, sensor will transmit the data to the sink. All of the composed data is transmitted to the sink from various nodes within one round itself. The packet sent by the node consist of its own data duration and waiting duration. Cross routing algorithm tackles the problems and challenges at several layers at once. Due to this reason these protocols are actually supportive for enhancing the performance of a network on the whole.

In[38], G.R Tsouri presented a routing strategy in which each nodes have dissimilar energy. A node having maximum energy is selected as cluster head (CH). There is equal chance to be elected as a Cluster head in each round. Cluster head shares a plan to all other remaining nodes for transmission of their data. Urgency or significance of data is not addressed in this paper. The node having high priority data have to hold its transmission of data for its turn. This approach presumes that all node have equal priority data. In [56], Q. Nadeem et. al proposed a routing protocol where a forwarder node is chosen on the by a virtue of cost function to transmit data to Sink. The cost function defines parameters that are having maximum residual energy and minimum distance with sink; however significance of data is not defined in cost function. Relay node compose all data from other nodes and transmit it to sink node. Nodes having highly urgent data can transmit straight to the sink node. Collection of data from all other nodes may cause conflict of data and can result in transmission delay. These routing protocols do not consider the effect of change in body posture.

In [8], S. Ahmed presented a protocol Co-LAEEBA to improve the performance in terms of path loss and cooperative learning. A cost factor is presented, to select the most suitable node to forward the data to the sink while keeping in view the hop-count and residual energy of the node. It shows improvement in terms of throughput, pathloss, residual energy, and stability period over existing protocols.

In [39] EERP, the Honghai et al. proposed energy efficient routing algorithm in order to transmit data in a reliable way. In order to show the validity of proposed approach the author considered various parameters like residual energy, bandwidth, hop-count, efficiency of transmission of data. It aims to increase the network life by considering these parameters in cost function and to increase the reliability of data by dynamically choosing the next hop. It shows improvement in terms of efficient energy utilization and increased network lifetime as compared to PERA and NEW-ATTEMPT routing protocols.

In [40], the Kaleem et al. presented a Dual Sink using Clustering in Body area network-DSCB protocol that aims to increase the lifetime of a network by utilizing the concept of two sink nodes. Based on some parameters like transmission power, residual energy, and hop-count, a Cost Function is designed. This proposed algorithm outperforms in terms of throughput, network stability, and delay compared to SIMPLE and DARE protocols.

In [41], the author proposed a protocol called “Energy Optimized Congestion Control based on Temperature Aware Routing Algorithm (EOCC-TARA)” using “Enhanced Multi-objective Spider Monkey Optimization (EMSMO)” for Software Defined Network-based WBAN to handle the problems related to energy efficiency, temperature, congestion. This algorithm outperforms in terms of temperature, network life-time, energy, congestion, throughput, and transmission rate.

In [12], V. Navya proposed energy efficient algorithm for the transmission of critical data where a threshold value is defined for sensed data and Cost Function is used for efficient utilization of energy. This algorithm performs better in terms of throughput, energy, stability period, network life-time compared to existing routing technique.

For temperature analysis, the implanted sensor nodes on human body produce electrical and magnetic field in response to radio signal which prompts to increase the temperature of sensor nodes due to circuit energy consumption and antenna radio absorption. Due to this, the temperature sensitive areas of human body may get damaged in long run i.e. swelling of some tissues, synthesized reactions,

and reducing blood pressure. In creation of WBAN, thermal-aware technology is commonly deployed. A technique called Specific Absorption Rate (SAR) is used to estimate thermal changes in WBAN. SAR is presented in [29] and the energy absorbed by human tissues as a result of radio frequency of electromagnetic field. Equation given below contains the SAR calculation formula.

$$SAR = \frac{\sigma |E^2|}{\rho} (W/kg)$$

Here,  $\sigma$  is tissue's mass density, "E" is "radiation induced electric field intensity", and " $\rho$ " is "tissue's dielectric conductivity". Temperature rise need to be considered in order to avoid tissue damage and temperature rise of sensor node. Following algorithm is used for detection of hotspot for the choice of forwarder node for data transmission. The equation given above calculates the specific absorption rate i.e the amount of energy absorbed by the body during the transmission and reception of data signal among sensor nodes.

In the table 2.1 given below we find the strengths and weaknesses of some protocols and then in second table 2.2 we categorize some protocols based on some parameter.

### 2.3 Related Work Analysis

We have performed an analysis on the basis of literature review and compared the work proposed by different authors on the basis of above questions. We categorized different research papers based on the strengths and weaknesses. On the basis of weaknesses identified, we find a research gap mentioned below. Research gap mainly focused on energy consumption, temperature rise, and mobility of sensor nodes.

In table 2.1 below, objectives, strengths, and weaknesses are given.

TABLE 2.1: Strengths, Weaknesses, and Objectives of Protocol

Protocol	Objective	Strengths	Weaknesses
IM-SIMPLE	Reducing energy consumption	Has better energy consumption, throughput, stability	Good packet drop rate
CO-LAEEBA	To provide energy efficient and link aware protocol	Low path loss, High stability period, network life time. Better energy consumption and high throughput.	High end-to-end delay
RE-ATTEMPT	To increase network life time and to redirect the packet if the hotspot found.	Decreases packet loss	Network life time is reduced.
M-ATTEMPT	To Reduce delay, energy consumption, and temperature rise	Increases network life time and also decreases packet loss ratio.	Alternative route selection is proposed if any nodes fails and also its non-uniform distribution of load on nodes
LTRT	To reduce the increase in temperature rise of sensor nodes deployed on a body by using Dijkstra algorithm with weight of temperature.	Has lower average hop-count, takes advantage of both SHR and LRT, and reduces temperature rise of sensor nodes.	—
DARE	To reduce energy consumption	Increased network life time and reduced energy consumption	High packet delay



Continued Table: 2.1 Strengths, Weaknesses, and Objectives of Protocol

Protocol	Objective	Strengths	Weaknesses
TARA	Avoiding hotspot while transmitting data packet	Has ability to balance the temperature and also as compared to the shortest hop mechanism it offers lower maximum temperature rise	Short network life time, increases packet delay
EERP-2021	To reduce energy consumption at source node,	Increases network life time, Reduces traffic load, and less energy consumption.	Prone to link failure and also postural movement not considered.
E-HARP	Increases network life time and ensure reliable data transmission	Increases packet delivery ratio, throughput and network life time.	Temperature rise of node not considered
SEAR	To improve the process of route request and route response also to decrease network delay in case of failure.	Increases throughput, decreases energy consumption and end to end delay.	Prone to link failure and frequent re-routing which cause additional computational overhead and also do not mobility, temperature rise also not considered.
DSCB	To overcome the problem of path-loss using clustering approach and to enhance network life-time	Increases network stability, Reduces energy consumption and causes less end to delay.	Additional installation of sink increases overall system cost.
ATEAR	To reduce energy consumption and temperature rise of sensor nodes to achieve stability and efficiency in routing.	Increases network life time and throughput	Mobility of sensor nodes is not considered.

In recent years, edge computing is gaining much attention from researchers and industry due to its promising benefits. With the increase in IOT devices, the data also grows. In order to decrease data, edge computing is used which allows to perform computation at edge before passing or transmitting that data to the cloud.

Edge denotes a network or computing resources that resides amongst IoT and cloud centers. Realistically, edge computing is performed close to the IoT sources to save the bandwidth cost that is related with moving unprocessed data to the cloud from data source, to avoid latency issues and to shrink the quantity of data send to the cloud. Here, In the edge computing paradigm sensors data produces data which is collected and sent by the central or sink nodes towards Edge. The sensors may produce large amount of data which are subsequently analyzed to extract analytics, statistics, or to determine the reactions to the events.

Current researchers are exploring how to improve the competences at edge to provision sensor network and its needs. Edge computing can provide better services with better quality and response than cloud computing. Also it helps health care, which generates 50 petabytes of data every year on average, can better optimize the collection, storage and analytics of data. Due to escalation in number of IoT network, data sources like sensors nodes, implanted devices, and personal devices results in big data due to which there is a need of edge network which involves local storage, data pre-processing, and data filtration close to source of data. Data reduction on edge network can prevent I/O bottlenecks, reduces bandwidth, energy storage, and energy costs. There are various data reduction practices available but modern methods are classified into four key types i.e. “data accumulation”, “data prediction”, “data compression”, and “adaptive sampling”.

In [42], Dehkordi SA et al. reviewed some data aggregation techniques and presented their own aggregation protocols and techniques for Wireless Sensor Network in IoT.

In [43], Grolinger et al. proposed a technique where they merge edge and cloud for data analytics where a deep learning approach is presented for edge

while machine learning on the cloud. In order to reduce the data dimension, the encrypted part of the auto-encoder is placed at edge and the reduced data is sent to cloud which can either be extended or decoded to original feature using decoder part of encoder or can be used directly for machine learning. Results shows that “50%” of data reduction does not have significant impact on classification accuracy while “77%” caused “1%” change.

In [44], Aloqaily et al. proposed a edge –computing framework for supporting emerging health care systems for efficient resource management which was validated using Resource Prevention Net (PRN petri net) and shows demonstration in general hospital for non-consumable medical resources which have two emergency departments having shared billing and radiology effects but different unique resources. Average patient time, resource utilization, and length of stay are the metrics used for efficiency and performance evaluation. The results shows improvement by integrating PRN with edge.

In literature, we investigated that how data reduction methods can be applied on edge. Edge computing enables the IoT system to deal with intermittent connectivity and process data faster otherwise the edge need to transmit high amount of unprocessed data to the cloud which may causes traffic congestion.

The data collected from remote and local sensing devices and networks, network logs, internet-enabled data streams brings enormously multi-format, heterogeneous, multi-source, aggregated and uninterrupted big data. Efficient handling of big data is the key challenge addressed by researchers.

In [45], Waala et al. presented a mechanism for removing noise and unwanted reflections from the data being transferred by the sensor nodes, the model was developed using adaptive filter i.e. Recursive Least Square (RLS) and Finite Impulse Response (FIR). It aims to minimalize the size of data being sent by considering energy constraint. The experimental results shows that it improved the performance to approximately 20% and reducing the energy consumption by 95%, it improves the performance of network overall by 19%. In [46], W. Wu et al. presented a technique for monitoring water distribution systems. They said that

there is a need to reduce the amount of data being transmitted for expanding the lifetime of network and to enhance the excellence of monitoring. They use the dual prediction model and Principle Component Analysis (PCA) for monitoring hydraulic data based on Autoregressive moving average.

In [47], Mohammad et al. proposed a “voice disorder” treatment and assessment enabled by edge computing and deep learning. Here, sensor nodes collect samples of user voice, which are sent to cloud after being processed on edge. Saarbrücken Voice Disorder (SVD) database is used for training, testing, and validating. In [48], Rahmani et al. presented a fog based health care architecture for hospitals/homes. It is a three layer architecture that consists of smart devices, edge layer, and cloud layer. Edge layer achieves the “data fusion”, “data filtering”, “data compression”, “data analysis”, “local storage” and “interoperating functions”. In [49], Salim C. et al. proposed an algorithm that is specifically designed for Wireless Video Sensor Network (WVSN), which is employed at the level of sensor nodes. This procedure uses “frame rate” to decrease quantity of images to be transmitted from sensor node to coordinator node. This approach is authenticated using “cpp” for “OpenCV” on “Raspberry PI-3”.

In [50], Wong Siaw et al. proposed a mechanism in which redundant gateways are used at edge to escalate the accessibility and reduce data by factor of “two”. It uses PIP to perform data reduction. It prevents the transmission of duplicate data. In order to improve the performance it splits the workload in even and odd fashion. It achieves 76% of the accuracy by forwarding 10% of data only.

## 2.4 Gap in the Literature

From this critical analysis it has been figured out that authors have combined the different techniques in order to deal with the issue of dis-connection of sensor nodes and also different authors considered the energy and temperature constraints to improve the stability of a network and for the better results. However, we have revealed that researched techniques have not considered the postural mobility

of human body along with consideration of temperature and energy constrains. The researchers uses the costly methods in order to deal with the issue of dis-connectivity.

Also, none of the authors have desinged any techniques which deal with multi-ple issues of WBAN like energy, temperature and postural mobility. Our research has shown that in order to deal with the issues of WBAN, there should be a sim-plest technique which do not increase the load on network and increases network life time.

Therefore, we have proposed a technique which is lightweight and efficient enough. After experimentation, we compared the results with two different routing techniques of WBAN to show enhancement in performance.

Surely, this approach will increase the network lifetime, residual energy, through-put and decrease packet drop rate and temperature rise of sensor nodes.

TABLE 2.2: Depicts the Summary of Related Work

Paper Reference	Year of Publication	Energy-aware approach	Thermal aware approach	Delay	Number of sink nodes	Packet drop rate	Mobility	Network life time	Network stability period
[[36]]	2015	Yes	No	Intermediate	Single	Intermediate	Yes	Medium	Intermediate
[[51]]	2013	Yes	No	Intermediate	Single	Intermediate	Yes	Medium	Intermediate
[[52]]	2015	Yes	No	Low	Single	Poor	No	Less	High
[[20]]	2016	No	Yes	High	Single	Good	No	High	Less
[[35]]	2013	No	No	Low	Single	Intermediate	No	Intermediate	Intermediate
[[53]]	2013	No	No	High	Single	Intermediate	No	Medium	Intermediate
[[54]]	2019	No	Yes	High	Single	Good	No	High	Less
[[55]]	2019	No	Yes	Intermediate	Single	Intermediate	No	High	Less
[[39]]	2019	Yes	No	Low	Single	Intermediate	No	Less	Intermediate
[[23]]	2018	Yes	No	Low	Single	-	No	Less	High
[[40]]	2019	Yes	No	Low	Dual	Less	Yes	Less	High
[[56]]	2020	Yes	No	Intermediate	Single	High	Yes	-	-
[[57]]	2020	Yes	Yes	Intermediate	Single	Intermediate	No	Less	Intermediate
[[19]]	2019	Yes	No	Less	Single	Less	No	Less	High
[[58]]	2020	Yes	No	Intermediate	Single	Intermediate	-	-	-
[[10]]	2021	Yes	Yes	Low	Dual	Less	Yes	High	High
[[59]]	2021	Yes	Yes	Intermediate	Single	Intermediate	No	High	High
[[60]]	2021	No	Yes	Less	Single	Intermediate	No	Intermediate	Intermediate
[[61]]	2021	No	Yes	Less	Single	Less	No	Intermediate	Intermediate
[[62]]	2020	Yes	No	Less	Single	Intermediate	No	-	-

# Chapter 3

## Proposed Methodology

### 3.1 Introduction

In the literature review section, we have identified most commonly used techniques for interconnecting sensor nodes in WBAN-Wireless Body Area network. Majority of the techniques considered energy consumption and temperature rise of the sensor nodes but ignore mobility of sensor nodes due to postural movement of body which results in disconnection and increased packet loss.

To overcome the gap in existing techniques, we have proposed a new technique which considers six postural movements of body and find different routing paths in case of disconnectivity. It utilizes cost function for selection of forwarder node. Forwarder node is chosen by keeping in view the constraints of sensor node.

Chapter 3 is divided into different sections. Section 3.2 describes proposed architecture, Section 3.3 System Model, and section 3.4 is Data Transmission.

### 3.2 Proposed Architecture

In our proposed architecture thirteen heterogeneous sensors nodes are deployed on the body. The data is directly transmitted to sink node or via a forwarder

node. The data is then sent to edge where some processing take place in order to reduce the bandwidth consumption from edge to cloud. After that, data is sent to cloud where AI/ML algorithms run to predict situation of patient. Recommended architecture is shown in fig. 3.1

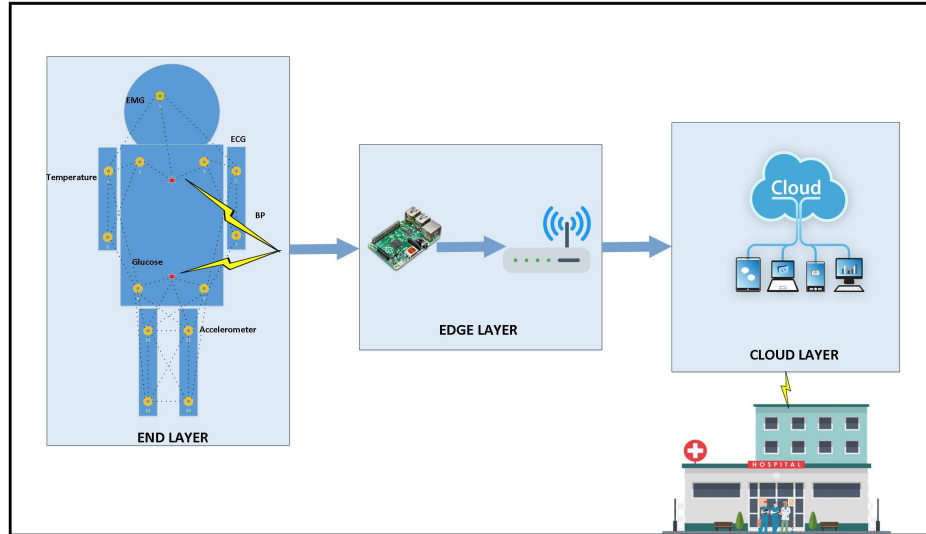

FIGURE 3.1: An Architecture of our Proposed Work

Structural outline of our proposed system is presented in fig 3.2 where the overall work flow of our system is shown. All the sensor nodes are deployed on human body, then initialization phase takes place where all the sensor nodes will store the minimum hop-count value to reach the sink. The sensor nodes having one-hop distance will get connected directly to the sink while all other sensor nodes transmit their data via a forwarder node.

In order to choose forwarder node, a cost function will be computed for each node and the node having maximum value in terms of energy and minimum temperature will be selected as forwarder node.

For communication between different sensor node and sink node, we have used the class 3 of Bluetooth. In Bluetooth class 3, transmission range is 1m and the power consumption is 1mW which is far less than class 1 and 2 . Less power consumption of Bluetooth directly affects the energy consumption which is less in case of Bluetooth class 3. Energy consumption is improved by 5.7%. Moreover,



another reason for two-hop communication is the distance between sensor nodes and sink node. The distance affects the energy consumption i.e. more distance leads to more energy consumption.

The sink node is located at farthest distance from sensor node 4, 5, 6, and 7 as compared to sensor node 2,3, 8, and 9. If we allow direct transmission to the sink then it will consume more energy as the distance between the sender and receiver directly affects the energy consumption of the node. As given in equation under energy consumption model below.

More energy consumption leads to temperature rise of sensor node. Hence, it causes more energy absorption and can cause damage to human skin and tissues. Also, the direct communication to the sink can be affected by the interference.

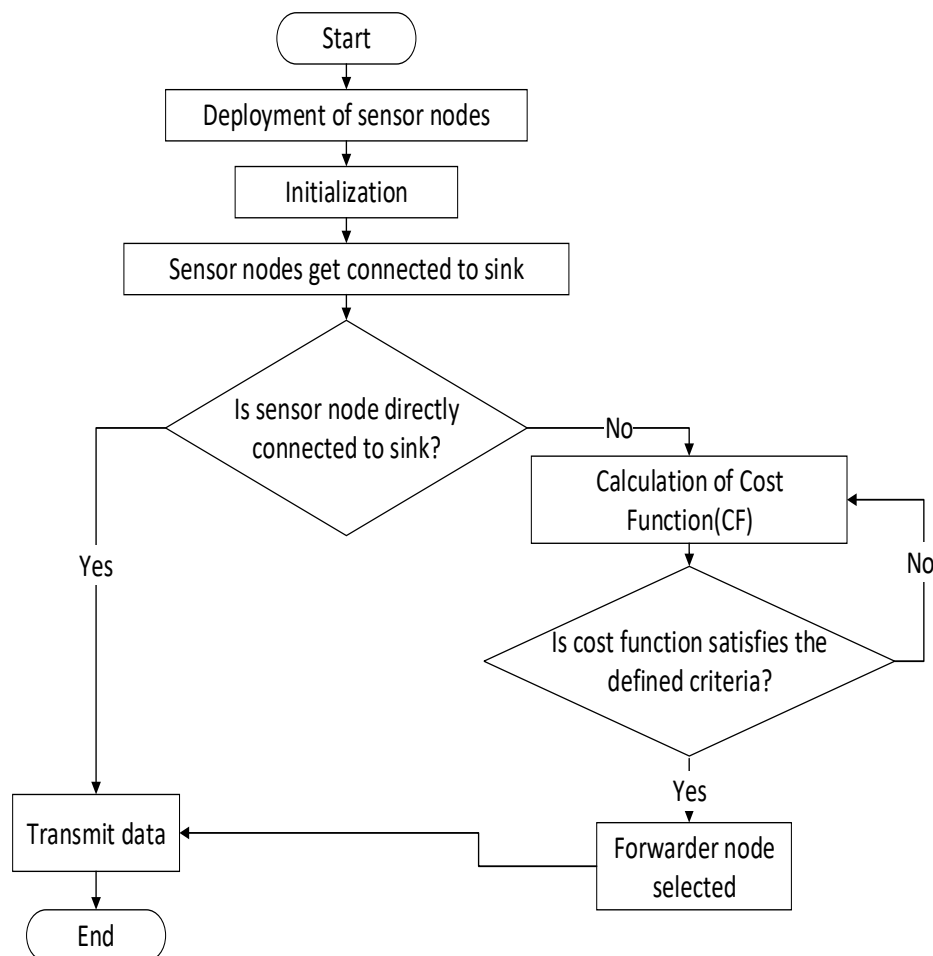

FIGURE 3.2: Work flow diagram of our proposed system

### 3.3 System Model

Low energy consumption and least temperature rise of sensor nodes with stable data communication and mobility support is important in WBAN. Our proposed protocol improves the connectivity of sensor nodes, increases network life time, and increases throughput by providing different routes for data transmission and keeping in view the energy, temperature.

In order to achieve this objective, concept of clustering is used in which two pre-defined sink nodes act as Cluster Head CH for other sensor nodes that can be called as Cluster Members CMs. The objective of using two sink nodes is to balance the load and to provide better connectivity.

Data can be forwarded directly or via forwarder node. In our proposed approach, two sink nodes are used where one is placed on chest and other is placed in abdominal area represented by red stars as shown in fig. 3.3.

We have taken 13 sensor nodes deployed on different positions on human body represented by yellow circles. Critical sensor nodes are deployed at one-hop distance while all other sensor nodes are located multi-hop distance and can carry out their communication via forwarder nodes. Sensor nodes can be located at non-moveable and moveable parts of the body. In this approach, we considered movement of arms only with five different postural movement of arms in different scenarios. This can be extended to movement of legs in future.

Optimum path selection is done by computing the Cost Function (CF) which depends on the constraints like energy and temperature of sensor nodes. If none of the nodes satisfies the criteria of Cost Function then backward forwarding is used that will be explained in section "Forwarder node selection" given below. Issues of less consumption of energy and temperature rise are tackled in this approach by choosing forwarder node with less temperature, maximum energy, minimum load, and minimum hop count. Energy and temperature model will be discussed later on. On the basis of energy and temperature of sensor nodes, Cost Function is calculated as mentioned above.

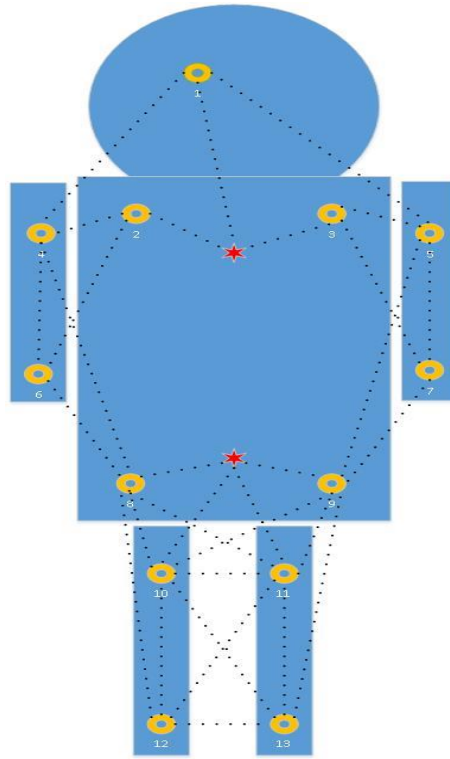

FIGURE 3.3: Sensor deployment of proposed system

### 3.3.1 Sensor Nodes in our Proposed System

Sensor nodes along with their functionality and position are mentioned below:

**Sensor node 1 (S1):**

EEG (Electroencephalography) sensor is positioned at the upper part of head to observe the electrical activity in the brain.

**Sensor node 2 (S2):**

Breathing sensor positioned at right side of chest to monitor respiratory rate.

**Sensor node 3 (S3):**

ECG sensor is positioned near heart to monitor the electrical activity of heart.

**Sensor node 4 (S4):**

It is positioned at the upper part of the right arm to monitor the BP.

**Sensor node 5 (S5):**

Galvanic Skin response sensor monitor the variations in sweat gland activity.

**Sensor node 6 (S6):**

This sensor is positioned at the right forearm to observe body temperature.

**Sensor node 7 (S7):**

SPO2 is positioned at the foreleg of right leg to observe blood oxygen level.

**Sensor node 8 (S8):**

Glucose is positioned at the right waist for monitoring the glucose level in order to ensure the correct measure of insulin injected.

**Sensor node 9 (S9):**

Accelerometer is positioned at the left waist used to observe the specific gait pattern in older people.

**Sensor node 10 (S10):**

EMG (Electromyography) sensor is placed at the upper part of the right leg to observe electrical activity caused by skeletal muscles.

**Sensor node 11 (S11):**

Lactic acid is a sensor positioned of upper part of the left leg for monitoring the lactate in sweat of body during extreme physical activity.

**Sensor node 12 (S12):**

Motion sensor is positioned at left foreleg to estimate motion signal for body's movement.

**Sensor node 13 (S13):**

Activity sensor is placed at right foreleg that is used to measure the 3-axis motion i.e. for position detection.

### 3.3.2 Initialization Phase

Each Sink Node (SN) broadcasts Hello message that comprised of its ID and location on the body. The Hello packet is received by neighbor nodes of sink which will store the value hop count value as 1. After receiving and storing this information, those nodes will broadcast the “Hello packet” and upon reception the neighbor nodes will make comparison of the hop-count information received by different nodes to save the information of node having minimum hop-count. The practice of re-broadcasting and updating the hop count cost goes on until all the nodes in the network stores hop-count value. Concluding this phase, each node will have information of minimum hop-count to reach the destination.

This phase is accountable for obtaining distance from sensor nodes to sink with current values of energy and temperature of each node in the neighbor. The suitable forwarder node election depends on steadiness of route which is based on temperature and energy of the node. The cost factor is evaluated for each node, on the basis of that cost, multiple forwarder nodes can be available.

The flow chart of initialization phase is given below in fig 3.4.

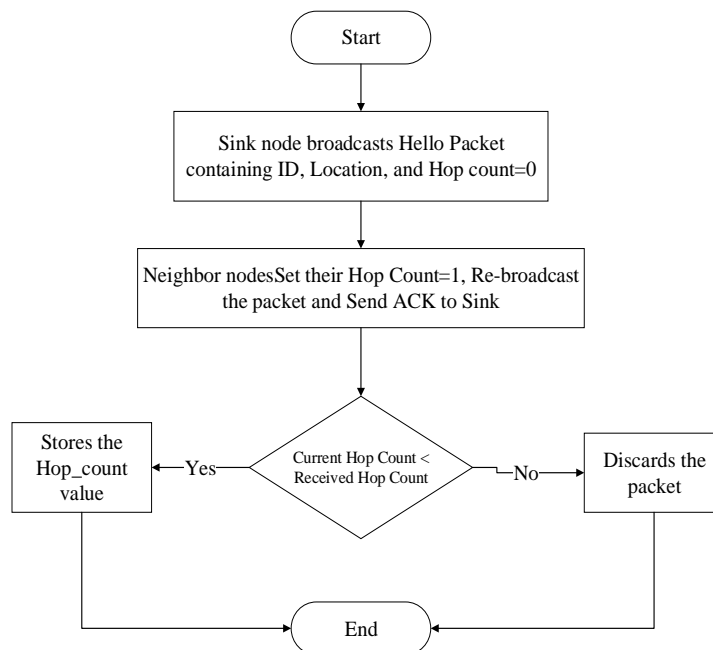

FIGURE 3.4: Initialization phase of proposed system

### 3.3.3 Temperature and Energy Model

An overview of temperature and energy models used in our proposed approach is given here. Temperature and energy constraints are highlighted as these are of main concern while designing WBAN.

#### 3.3.3.1 Analysis of Sensors' Temperature Parameter

Sensors positioned on human body, can send and receive data to the sink node in WBAN. The implanted sensor nodes on human body produces electrical and magnetic field in response to radio signal which prompt to increase in temperature of sensor nodes due to circuit energy consumption and antenna radio absorption. A technique called Specific Absorption Rate (SAR) is used to estimate thermal changes in WBAN. Equation given above in literature part contains the SAR calculation formula. Later, we found in literature that there is fixed increase and decrease in temperature that is 0.6 given in table above.

On the basis of above values that are defined we formed three cases for sensor nodes, each sensor node sends or receives data accordingly:

**Case 1:** Case 1: If (Node\_temp < Norm\_temp) then

Forwarder node can perform these actions:

Send and receive both high and low priority data

**Case 2:** *If (Node\_temp  $\geq$  Norm\_temp && Node\_temp < thr\_Temp) then*

Forwarder node can perform these actions:

Receive and forward high priority packets only

**Case 3:** If (Node\_temp > thr\_Temp) then

Goes to sleep mode and that node can't be selected as forwarder node

According to the cases defined above, we concluded that Forwarder node can only be selected in case 1 and 2. In case 3, node goes to sleep mode and once the temperature of sensor node decreases then it will activate. Also, it sends the awake message to neighbour node to inform about its availability.

$$Temp = \min_{\text{among neighbors}} \left( \frac{thr\_temp - Node\_temp}{thr\_temp} \right)$$

The node having minimum temperature among neighbors of source node can be selected as forwarder node.

### 3.3.3.2 Analysis of Sensors' Energy Parameter

Now there can be multiple node which fulfils the above criteria but there can be a single node selected as forwarder node i.e. its temperature is minimum among all of its neighbor nodes, proposed model that is given below is taken from [63].

During communication process different quantum of energy is consumed by sensor nodes. Energy consumption occurs throughout data transmission, aggregation of data, and reception of data but from previous research work, it is concluded that transmission of data costs most of the energy than receiving.

$$E_{rx}(k) = E_{elec} \times k \quad // \text{ energy consumed by receiving k-bits of data.}$$

$$E_{tx}(k, d) = E_{elec} \times k + E_{amp} \times k \times d^2 \quad // \text{ energy consumed by sending k-bits to node at distance "d".}$$

$$E_{elec} = \text{energy consumed by circuit while sending and receiving.}$$

$$E_{amp} = \text{consumed by power amplifier while sending data.}$$

**Residual energy is calculated as:**

$$E_i^{res} = E_{initial} - E_{icon}$$

$$E_i^{con} = E_{tx} + E_{rx}$$

$$E = \text{Max}(E_i^{res} \text{ in neighbors})$$

We also calculated the Energy consumption of sensor nodes without transmission i.e. idle case, when sensor nodes are also sensing the data.

### 3.3.3.3 Forwarder Node Selection

Our proposed system provides forwarder node selection which plays an important role for handling the different cases of mobility. As it is mentioned earlier, more energy is drained and temperature rises if packet is sent at large distance. So, in order to deal with this issue we make use of REQ and REP mechanism where a nodes sends “Request (REQ)” message to its neighbor nodes asking for its temperature, residual energy. Afterwards, the neighbor node transmits “Reply (REP)” message to the source node which contains information about recent temperature and energy. As soon as the required information is acknowledged by the source node, it will compute the Cost Function (CF) based on some parameter whose details will be given later on. Formula for computing the cost factor is given in equation 1.

$$CF = \min(\text{hop count}, \text{Load}) + \text{temperature} + E \quad (1)$$

The node searches for forwarder node in the neighbor with the strongest link quality to ensure the connectivity and data transmission towards sink node. There are various scenarios are defined i.e. best case, average case, and worst case in which a source node first looks for the forwarder node in best case, then in average case and at last it will look in worst case scenario. One exceptional case is also handled via backward forwarding mechanism, when a forwarder node don't find any node that is satisfying the criteria defined in Cost Function calculation then node return the packet to the previous node if no next hop is available. Along with this the temperature rise and low energy information is carried along with the packet in order to inform the precedent node. When the temperature drops down later, the node is responsible to notify about it.

### 3.3.3.4 Mobility Support

We handled the patient's mobility in terms of movement of arms in five different cases. We presented different routing paths when there is a movement, and a



sensing node can select the forwarder node based on cost factor which depends on maximum residual energy, minimum temperature, and minimum hop count. The effectiveness of this proposed scheme is presented by using thirteen different sensor nodes. The two sink nodes are placed, so that all other sensor nodes can send their data through different routing paths depending on availability of sensor node.

In case of posture mobility, the sensor nodes implanted on the moving part of the body i.e. arms can change their position which can result in change in topology that leads to disconnection to sink. To tackle such cases, mobility of sensor nodes needs to be handled. Our system handles five different cases of patient's mobility in terms of arms and it overcomes the issue of disconnectivity.

**Arm Mobility Scenarios** There are five different scenarios considered for the mobility of arm where a source node may look for optimal forwarder node for transmission of data. For each next transmission, forwarder node is chosen with best, average, worst, and exceptional case.

### **Scenario 1**

Scenario 1 is given in fig 3.5 where red stars represents two sink nodes while yellow circles represents sensor nodes.

### **Two-Hop Communication in Scenario 1**

In mobility scenario 1, the sensor node 4 selects sensor node 2 as forwarder node which will forward the data to the sink. Similarly sensor node 5 selects sensor 3 as forwarder node for transmission of data to sink and so on. If sensor node 2, 3, 8, 9, 10, or 11 are not available due to some reason like any of these nodes are in sleep mode due to temperature rise.

Sensing node can select from average or worst case if nodes from best case are in sleep mode.

Description of this scenario is given below:

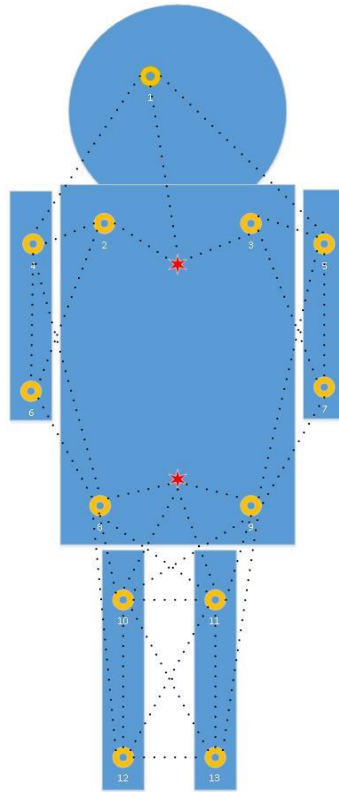

FIGURE 3.5: Scenario 1 of proposed system

### Routing Path Selection for Scenario 1

In our scenario, some sensors are directly connected to sink node that are Sensor node 1, 2, 3, 8, 9 while all other sensors i.e. Sensor node 4, 5, 6, 7, 10, 11, 12, and 13 needs some forwarder node for transmission of data.

For each node we have created best, average, and worst case scenarios which is given in table 3.1.

Forwarder nodes are estimated in advance based on the distance between sensing node and the node that can be selected as forwarder node as given below:

- Sensor node 4 can select sensor node 2 as best option, sensor node 1 or 8 in average case, or otherwise can select sensor node 6 in worse case as this node will consume more energy as compared to sensor node 2,1, or 8.

- Sensor node 5 can select sensor node 3 as best option, sensor node 1 or 9 in average case, or otherwise can select sensor node 7 in worse case as this node will consume more energy as compared to sensor node 3,1, or 9.
- Sensor node 6 can select sensor node 8 as best option, sensor node 4 in average case, or otherwise can select sensor node 2 in worse case as this node will consume more energy as compared to sensor node 8 or 4.
- Sensor node 7 can select sensor node 9 as best option, sensor node 5 or 8 in average case, or otherwise can select sensor node 3 in worse case as this node will consume more energy as compared to sensor node 9,5, or 8.
- Sensor node 10 can select sensor node 8 as best option, sink in average case as sink node will consume more energy as compared to sensor node 8.
- Sensor node 11 can select sensor node 9 as best option, sink in average case as sink node will consume more energy as compared to sensor node 9.
- Sensor node 12 and 13 can select sensor node 10 as best option, sensor node 11 in average case, or otherwise can select sensor node 8 in worse case as this node will consume more energy as compared to sensor node 10 or 11.

TABLE 3.1: Best, average and worst case for scenario 1

Sensor nodes	Best case	Average case	Worst case
Sensor node 4	S 2(12.7cm)	S 1,8(25.4cm,45.72cm)	S 6(55.7cm)
Sensor node 5	S 3(12.7cm)	S 1,9(25.4cm,45.72cm)	S 7(55.7cm)
Sensor node 6	S8(30.49cm)	S 4(55.7cm)	S 2(60.96cm)
Sensor node 7	S 9(30.49cm)	S 5(55.7cm)	S 3(60.96cm)
Sensor node 10	S 8(30.48cm)	Sink (45.72cm)	-
Sensor node 11	S 9(30.48cm)	Sink 45.72cm)	-
Sensor node 12	S 10(26.2cm)	S 11(83.82cm)	S 8 (129.54cm)
Sensor node 13	S 11(26.2cm)	S 10(83.82cm)	S 9(129.54cm)

## Scenario 2

Scenario 2 is given in fig 3.6 where red stars represents two sink nodes while yellow circles represents sensor nodes.

### Two-Hop Communication in Scenario 2

In mobility scenario 2, the sensor node 6 selects sensor node 4 as forwarder node which will forward the data to the sink. Similarly sensor node 7 selects sensor node 5 as forwarder node for transmission of data to sink. If sensor node 4 or 5 are not available due to some reason like any of these nodes are in sleep mode due to temperature rise. Sensing node can select from average or worst case if nodes from best case are in sleep mode.

Description of this scenario is given below:

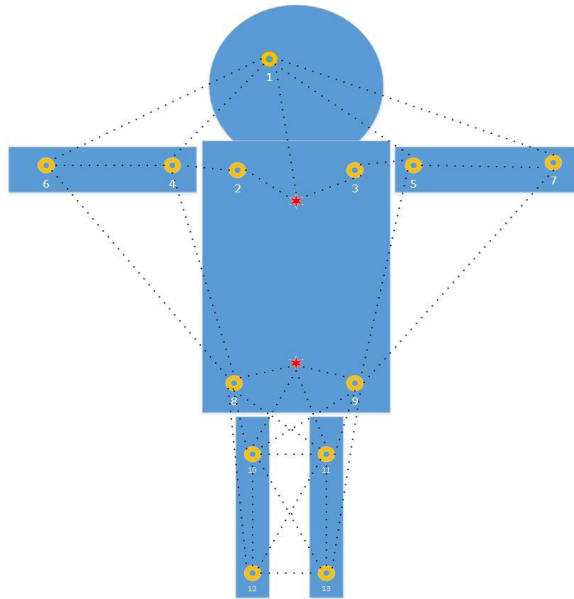

FIGURE 3.6: Scenario 2 of proposed system

### Routing Path Selection for Scenario 2

When the sensor nodes change their position due to postural mobility. This scenario affects two sensor nodes that are sensor node 6 and 7.

For each node we have created best, average, and worst case scenarios which is given in table 3.2. Forwarder nodes are estimated in advance based on the distance between sensing node and the node that can be selected as forwarder node as given below:

- Sensor node 6 and 7 can select sensor node 4, 5 as best option respectively, sensor node 1 in average case, or otherwise can select sensor node 8, 9 in worse case as this node will consume more energy as compared to sensor node 4, 5 or 1.

TABLE 3.2: Best, average and worst case for scenario 2

Sensor nodes	Best case	Average case	Worst case
Sensor node 6	S 4(55.7cm)	S 1(91.44cm)	S 8(104.11cm)
Sensor node 7	S 5(55.7cm)	S 1(91.44cm)	S 9(104.11cm)

### Scenario 3

Scenario is given in fig 3.7 where red stars represents two sink nodes while yellow circles represents sensor nodes.

#### Two-Hop communication in scenario 3

In mobility scenario 3, the sensor node 6 and 7 selects sensor node 1 as forwarder node which will forward the data to the sink. If sensor node 1 is not available due to temperature rise. Sensing node can select from average or worst case. Description of this scenario is given below:

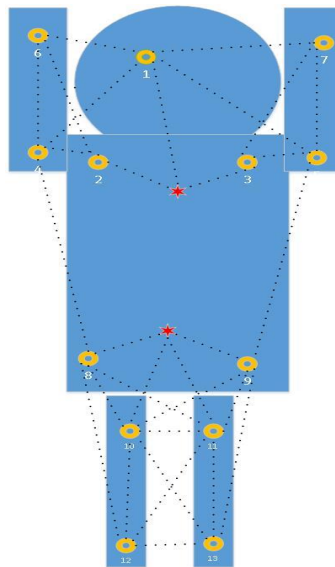

FIGURE 3.7: Scenario 3 of proposed system

### Routing Path Selection for Scenario 3

When the sensor nodes change their position due to postural mobility. This scenario affects two sensor nodes that are sensor node 6 and 7. For each node we have created best, average, and worst case scenarios which is given in table 3.3. Forwarder nodes are estimated in advance based on the distance between sensing node and the node that can be selected as forwarder node as given below:

- Sensor node 6 can select sensor node 1 as best option, sensor node 4 in average case, or otherwise can select sensor node 2 in worse case as this node will consume more energy as compared to sensor node 1 or 4.
- Sensor node 7 can select sensor node 1 as best option, sensor node 5 in average case, or otherwise can select sensor node 3 in worse case as this node will consume more energy as compared to sensor node 1 or 5.

TABLE 3.3: Best, average and worst case for scenario 3

Sensor nodes	Best case	Average case	Worst case
Sensor node 4	S 2(12.7cm)	S 1,8(25.4cm,45.72cm)	S 6(55.7cm)
Sensor node 5	S 3(12.7cm)	S 1,9(25.4cm,45.72cm)	S 7(55.7cm)
Sensor node 6	S 1(10.4cm)	S 4(55.7cm)	S 2(66.04cm)
Sensor node 7	S 1(10.4cm)	S 5(55.7cm)	S 3(66.04cm)

### Scenario 4

Scenario 4 is given in fig 3.8 where red stars represent two sink nodes while yellow circles represent sensor nodes.

#### Two-Hop Communication in Scenario 4

In mobility scenario 4, the sensor node 6 and 7 select sensor node 1 as forwarder node which will forward the data to the sink. If sensor node 1 is not available due to some reason like any of these nodes are in sleep mode due to temperature rise. Sensing node can select from average or worst case if nodes from best case are in sleep mode. Description of this scenario is given below:

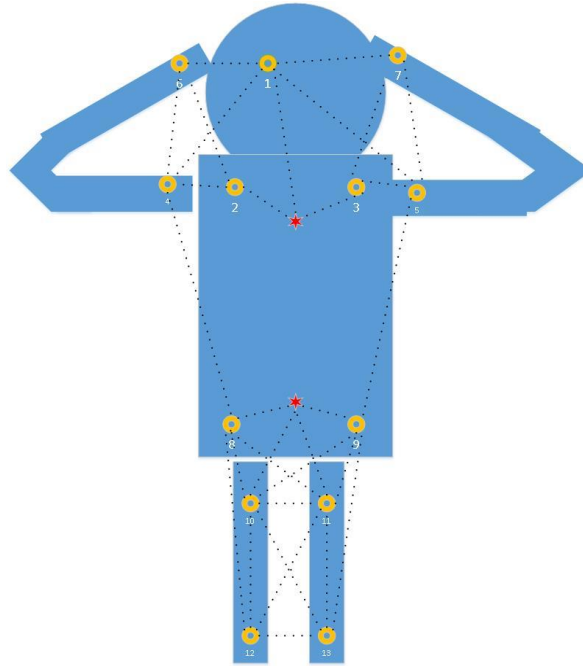

FIGURE 3.8: Scenario 4 of proposed system

### Routing Path Selection for Scenario 4

When the sensor nodes change their position due to postural mobility. This scenario affects two sensor nodes that are sensor node 6 and 7.

For each node we have created best, average, and worst case scenarios which is given in table 3.4.

Forwarder nodes are estimated in advance based on the distance between sensing node and the node that can be selected as forwarder node as given below:

- Sensor node 6 can select sensor node 1 as best option, sensor node 4 in average case, or otherwise can select sensor node 2 in worst case as this node will consume more energy as compared to sensor node 1 or 4.
- Sensor node 7 can select sensor node 1 as best option, sensor node 5 in average case, or otherwise can select sensor node 3 in worst case as this node will consume more energy as compared to sensor node 1 or 5.

TABLE 3.4: Best, average and worst case for scenario 4

Sensor nodes	Best case	Average case	Worst case
Sensor node 6	S 1(10.4cm)	S 4(12.4cm)	S 2(25.7cm)
Sensor node 7	S 1(10.4cm)	S 5(12.4cm)	S 3(25.7cm)

### Scenario 5

Scenario 5 is given in fig 3.9 where red stars represents two sink nodes while yellow circles represents sensor nodes.

#### Two-Hop Communication in Scenario 5

In mobility scenario 5, the sensor node 4, 5, 6, and 7 selects sensor node 2,3, and 6 respectively as forwarder node which will forward the data to the sink. If sensor node 1 is not available due to some reason like any of these nodes are in sleep mode due to temperature rise. Sensing node can select from average or worst case if nodes from best case are in sleep mode.

Description of this scenario is given below:

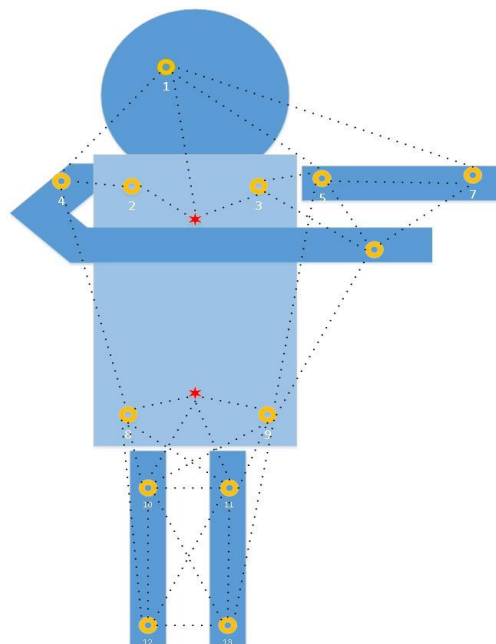

FIGURE 3.9: Scenario 5 of proposed system



### Routing Path Selection for Scenario 5

When the sensor nodes change their position due to postural mobility. This scenario affects two sensor nodes that are sensor node 6 and 7. For each node we have created best, average, and worst case scenarios which is given in table 3.5. Forwarder nodes are estimated in advance based on the distance between sensing node and the node that can be selected as forwarder node as given below:

- Sensor node 4 can select sensor node 2 as best option, sensor node 1 or 8 in average case, or otherwise can select sensor node 6 in worse case as this node will consume more energy as compared to sensor node 2, 1 or 8.
- Sensor node 5 can select sensor node 3 as best option, sensor node 1 or 9 in average case, or otherwise can select sensor node 7 in worse case as this node will consume more energy as compared to sensor node 3, 1 or 9.
- Sensor node 6 can select sensor node 3 as best option, sensor node 5 or 7 in average case, or otherwise can select sensor node 9 in worse case as this node will consume more energy as compared to sensor node 3, 5 or 1.
- Sensor node 7 can select sensor node 6 as best option, sensor node 5 in average case, or otherwise can select sensor node 1 in worse case as this node will consume more energy as compared to sensor node 6 or 5.

TABLE 3.5: Best, average and worst case for scenario 5

Sensor nodes	Best case	Average case	Worst case
Sensor node 4	S 2(12.7cm)	S 1,8(25.4cm,45.72cm)	S 6(55.7cm)
Sensor node 5	S 3(12.7cm)	S 1,9(25.4cm,45.72cm)	S 7(55.7cm)
Sensor node 6	S 3(10.16cm)	S 5,7(15.24cm,25.4cm)	S 9(45.72cm)
Sensor node 7	S 6(25.4cm)	S 5(55.7cm)	S 1(56.8cm)

### Scenario 6

Scenario 6 is given in fig 3.10 where red stars represent two sink nodes while yellow circles represent sensor nodes.

### Two-Hop Communication in Scenario 6

In mobility scenario 6, the sensor node 4, 5, 6, and 7 selects sensor node 2, 3, 7, and 2s as forwarder node which will forward the data to the sink. If sensor node 1 is not available due to some reason like any of these nodes are in sleep mode due to temperature rise. Sensing node can select from average or worst case if nodes from best case are in sleep mode.

Description of this scenario is given below:

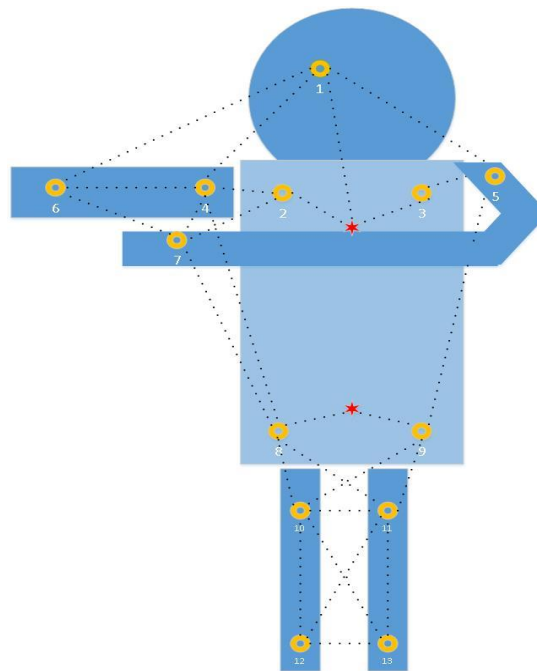

FIGURE 3.10: Scenario 6 of proposed system

### Routing Path Selection for Scenario 6

When the sensor nodes change its position due to postural mobility. This scenario affects two sensor nodes that are sensor node 6 and 7.

For each node we have created best, average, and worst case scenarios which is given in table 3.6. Forwarder nodes are estimated in advance based on the distance between sensing node and the node that can be selected as forwarder node as given below:

- Sensor node 4 can select sensor node 2 as best option, sensor node 1 or 8 in average case, or otherwise can select sensor node 6 in worse case as this node will consume more energy as compared to sensor node 2, 1 or 8.
- Sensor node 5 can select sensor node 3 as best option, sensor node 1 or 9 in average case, or otherwise can select sensor node 7 in worse case as this node will consume more energy as compared to sensor node 3, 1 or 9.
- Sensor node 6 can select sensor node 7 as best option, sensor node 1 in average case, or otherwise can select sensor node 4 in worse case as this node will consume more energy as compared to sensor node 7 or 1.
- Sensor node 7 can select sensor node 2 as best option, sensor node 4 or 6 in average case, or otherwise can select sensor node 8 in worse case as this node will consume more energy as compared to sensor node 2, 4, or 6.

TABLE 3.6: Best, average and worst case for scenario 6

Sensor nodes	Best case	Average case	Worst case
Sensor node 4	S 2(12.7cm)	S 1,8(25.4cm,45.72cm)	S 6(55.7cm)
Sensor node 5	S 3(12.7cm)	S 1,9(25.4cm,45.72cm)	S 7(55.7cm)
Sensor node 6	S 7(25.4cm)	S 1(45.72cm)	S 4(55.7cm)
Sensor node 7	S 2(10.16cm)	S 4,6(15.24cm,25.4cm)	S 8(45.72cm)

### 3.4 Data Transmission

Data packet is send from one sensor to sink that can be sent directly or via forwarder node. Forwarder node is choosen on the basis of Cost Function and defined mobility scenarios in case of postural movement. The data is keep forwarding from one sensor node to other until it reaches to the sink node. From the sink node data is then forwarded to the edge where some data filtration algorithm applies. From edge data is forwarder to the cloud with alert message in case of emergency situation.

# Chapter 4

## Results and discussion

### 4.1 Introduction

The main goal of this thesis is to overcome the multiple challenges of WBAN like limited battery time, mobility, limited energy, routing, etc , and provide a robust mechanism that handles dis-connectivity while providing data transmission with minimum delay and information loss. This chapter contains details about simulation results and evaluation. Results are compared with existing techniques to validate and show improvement by using our proposed approach.

### 4.2 Simulation Environment

For our simulation, we have used Ubuntu LTS 20.04 with hardware containing, Core i7 10th Generation 10510U CPU Clock speed 1.8 Ghz, 16 GB RAM. For evaluation and comparison of our proposed approach with other related approaches, NS3 (Network Simulator version 3). It has become widely used network simulator in academic circles. In order to prove the legitimacy of our proposed mechanism, we created the network environment in NS3. We authenticated it through comparison with iM-SIMPLE and mobTHE issued curves using the parameters given below.

### 4.3 Metrics and Parameters Settings

We demonstrate the performance of our proposed approach in respect of residual energy, network life time, temperature rise, throughput, and packet drop rate. These evaluation matrices are explained as:

#### **Residual energy**

Average total left over energy after each round during the simulation time.

#### **Network life time**

Time from beginning of the network process till the death of last sensor node.

#### **Temperature rise**

The rate at which temperature of each node increases during data transmission of overall network.

#### **Throughput**

The rate at which data is sent successfully to the sink

#### **Packet drop rate**

The frequency at which data packets are dropped throughout transmission of data to sink node.

We validated the proposed approach under the metrics given above by comparing it with mobTHE and iM-SIMPLE protocol using the parameters given in table 4.1. The reason for choosing these two papers for comparison is, mobTHE protocol takes into account energy, temperature and mobility issues of WBAN but it used some complex mechanism in case of mobility i.e. handoff mechanism. We tried to use simpler method, in case of mobility that can lead to disconnection. The other research paper iM-SIMPLE is taken for comparison because most of the papers validated their approach by comparing with it so, we also make comparison with this to show validity of our approach.

TABLE 4.1: Simulation parameters

Parameters	Value
No. of Simulation rounds	8000
Area	3m x 3m
Sink nodes	2
Number of sensor nodes	13
Initial energy of sensor node	"0.5J"
$E_{Tx-elec}$	"16.7 nJ/bit"
$E_{Rx-elec}$	"36.1 nJ/bit"
$E_{amp}$	"1.97 nJ/bit/mn"
Initial temperature	"36°C"
Packet length	4000/296 bits
Increment in temperature	0.01°
Decrement in temperature	0.02°
Decrement in energy per packet transmission	"6.68e4 + 2.6e4d3.38"

Data rates of different sensors are given in table 4.2.

TABLE 4.2: Description of data rates of sensor nodes

Sensor Nodes	Data rate
Respiratory rate	240 bps
Blood pressure	250 kbps
Temperature	70 to 90 kbps
Glucose	1600 bps
Accelerometer	45 to 100 kbps
EEG	90 kbps
ECG	288 kbps
GSR	1-10 bps
SPO2	16 bps
EMG	320 kbps
Lactic acid	48 bps
Motion sensor	35 kbps

Sensor nodes are positioned at diverse location on human body as shown in figure 3.5 above and the information about x and y location of different sensors deployed on body in simulation is given in table 4.3. We found this positions of sensor nodes from different research that tells which sensor should be placed at which body area to give accurate results.

TABLE 4.3: Description of positions of sensor nodes

Sensor Node	X-axis (m)	Y-axis (m)
S1	1.38	0.64
S2	1.3	0.76
S3	1.5	0.76
S4	1.58	0.78
S5	1.22	0.78
S6	1.16	0.92
S7	1.64	0.92
S8	1.3	1.02
S9	1.5	1.02
S10	1.34	1.12
S11	1.46	1.12
S12	1.3	1.28
S13	1.5	1.28
Sink 1	1.4	0.8
Sink 2	1.4	0.96
Edge	1.6	1.6

### 4.3.1 Network Topology

Network topology of our proposed approach is illustrated in fig 4.1. Sensor nodes are positioned on human body where four sensor nodes are connected directly to sink while other nodes transmit their data via forwarder node. Sink nodes send data to edge node where simple data filtration is performed in order to save bandwidth utilization from edge to cloud.

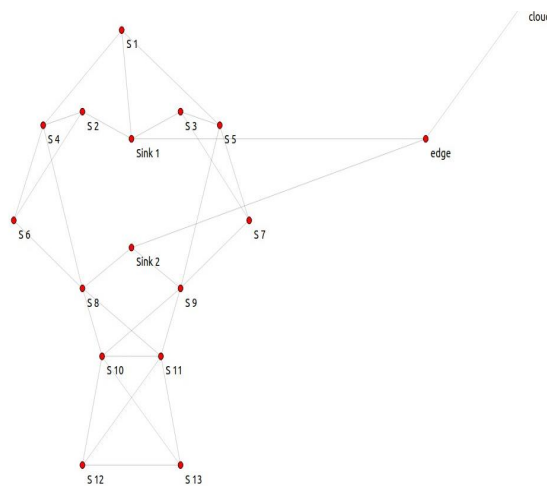

FIGURE 4.1: Topological diagram of our proposed system

### 4.3.2 Comparison

In order to validate our research, we made comparison with two different routing protocol i.e. mobTHE protocol which is published recently in 2021 and iM-SIMPLE protocol which was presented in 2014. We made comparison for five different metrics which are explained above in order to prove the authenticity of our proposed approach. The detail comparison on the basis of metrics is given below.

#### 4.3.2.1 Residual Energy

Fig 4.2 demonstrates the total residual energy compared to each round. It is concluded that our proposed mechanism saves more energy as compared to iM-SIMPLE and mobTHE protocol. This energy enhancement is because of the “On-demand” selection of forwarder node. Also, energy of sensor node is conserved when its not selected as forwarder node. This will drop consignment of sensor node and preserves more energy of WBAN’s sensor node. It also gives the chance of direct transmission to the sink node when none of the neighbors are satisfying the criteria of minimum temperature and maximum energy. To validate the average remaining energy of our proposed approach, mobTHE protocol and iM-SIMPLE protocol, we made the assessment at three different points i.e. at the start of round nearly at 500, mid of rounds nearly 3500, and at the end of rounds nearly 6000. As shown in fig 4.2, our proposed approach elevates the residual energy beyond 41.3% and 58.7% than mobTHE and iM-SIMPLE protocol respectively after using the Bluetooth class 3 for communication between sensor nodes and sink. There is an increase in overall residual energy by approximately 5.7% than using Bluetooth class A If the distance between the sensor nodes is doubled then there is 42.3% increase in energy consumption according to the energy consumption model given above. From this outcome, we identified and validated that distance can directly affect the energy consumption of the nodes. Energy consumption is mostly affected by the transmission of data rather than reception of data.



We also checked that how much energy is consumed without transmission, the energy consumed in idle case is 350 to 400 Joules per 1000 sec.

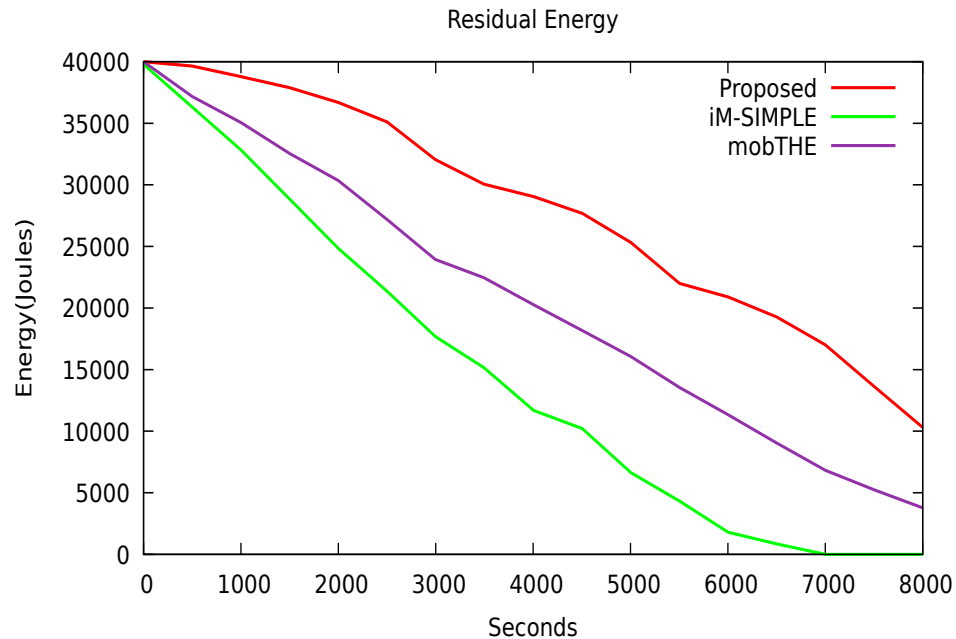

FIGURE 4.2: Comparison of residual energy with iM-SIMPLE protocol

#### 4.3.2.2 Network Life Time

Fig 4.3 illustrates the comparison of network lifetime compared to mobTHE and iM-SIMPLE protocol. In our proposed approach the first node completely exhausts at round 7400 and last node exhausts at round 13500. In mobTHE protocol, first node and last node died at round “6800” and “12000” respectively and in iM-SIMPLE protocol, the first node and last node died at round “5250” and “7520” respectively. This great improvement in network life time is due to the introduction of best, average and worse cases that helps the source to choose optimal forwarder node in respect of energy, temperature, distance, and hop count. It shall conserve the energy of sensor nodes, conserve energy of overall network, and prolongs network lifetime. By taking the average between three spots i.e. 1, 4 and 8, we deduce that our proposed approach conserves the energy of sensor nodes and prolongs the network life time by 7.9% over mobTHE and nearly 33.5% over iM-SIMPLE.

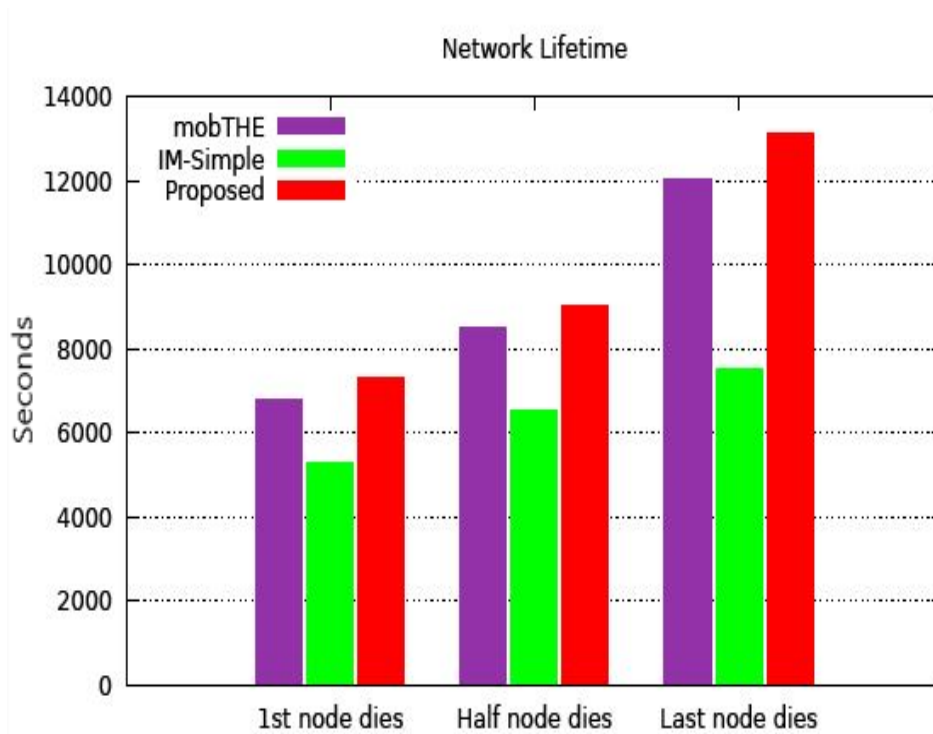

FIGURE 4.3: Comparison of Network life time with mobTHE protocol and iM-SIMPLE

#### 4.3.2.3 Temperature

Fig 4.4 illustrates the comparison of temperature rise of 13 sensor nodes in mobTHE and our proposed approach. We checked the temperature rise at every 1000 round and take the average. Our approach decreases the average temperature of sensors node by 23.62 % than mobTHE protocol. Furthermore, our approach showed more stability after reaching the threshold than mobTHE protocol. This enhancement is attained due to utilization of two sink nodes which divides the overall network load. It enables sensor nodes to utilize minimum temperature during transmission of data packets. It keeps the temperature of sensors within protected range for extended duration. The routing mechanism helps the sensor node to send its packets via short distance towards the sink in best case scenario. When the temperature of the sensor node reaches maximum threshold value then it goes to sleep mode until its temperature falls in the normal range of temperature. Whereas, iM-SIMPLE protocol doesn't consider temperature rise of sensor node.

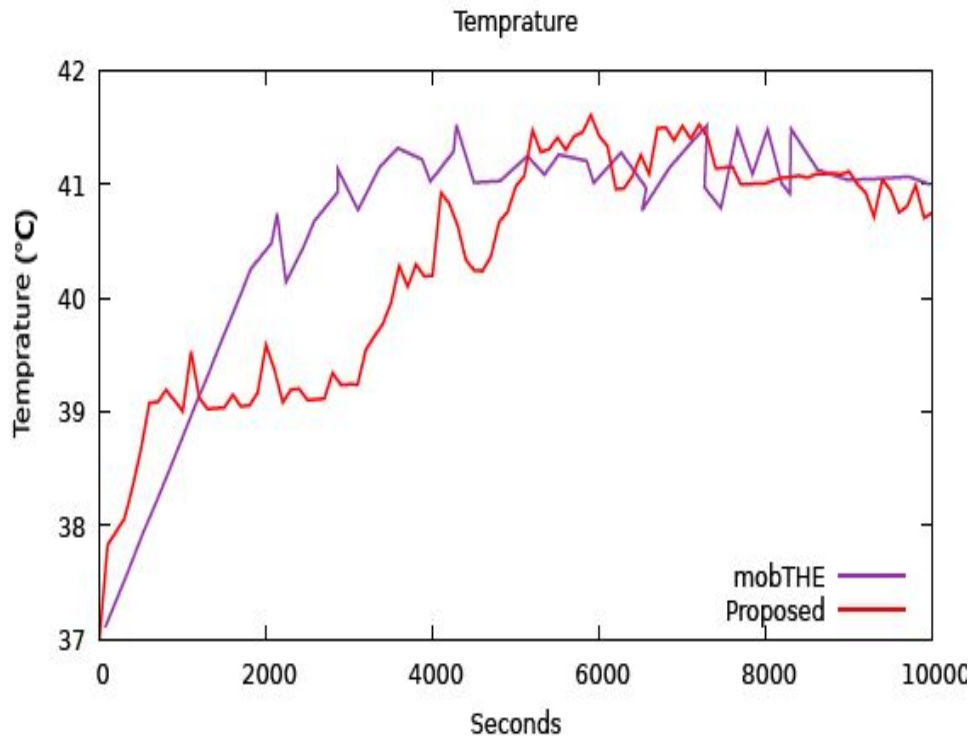

FIGURE 4.4: Comparison of temperature with mobTHE protocol

#### 4.3.2.4 Throughput

One of the important metric for measuring the performance of WBAN is throughput which is the rate of successful transmission of data packet towards sink node. Fig 4.5 illustrates that our proposed approach accomplishes greater throughput than mobTHE and iM-SIMPLE. By taking the average of throughput at three intervals i.e. “1000”, “4000”, and “6800” we concluded that our proposed approach boosts the throughput by 17.3% than mobTHE and 63.2% than iM-SIMPLE. This improvement is accomplished due to the deployment of two sink nodes and efficient selection of forwarder node in terms of energy, temperature, hop count, and distance.

Also due to the backward forwarding mechanism prevents increase in packet drop rate which results in increased network throughput and mobility of sensors nodes is handled efficiently i.e. by introducing alternate paths for routing in case of dis-connectivity of sensor nodes which also gives boost-up to the throughput. The graph for throughput is given as cumulative throughput because the comparison

research paper calculated it as cumulative throughput. If we calculate it as per unit time, it couldn't produce accurate and valid comparison. But, we calculated the throughput per unit time of our proposed approach and its shown in fig 4.6 below.

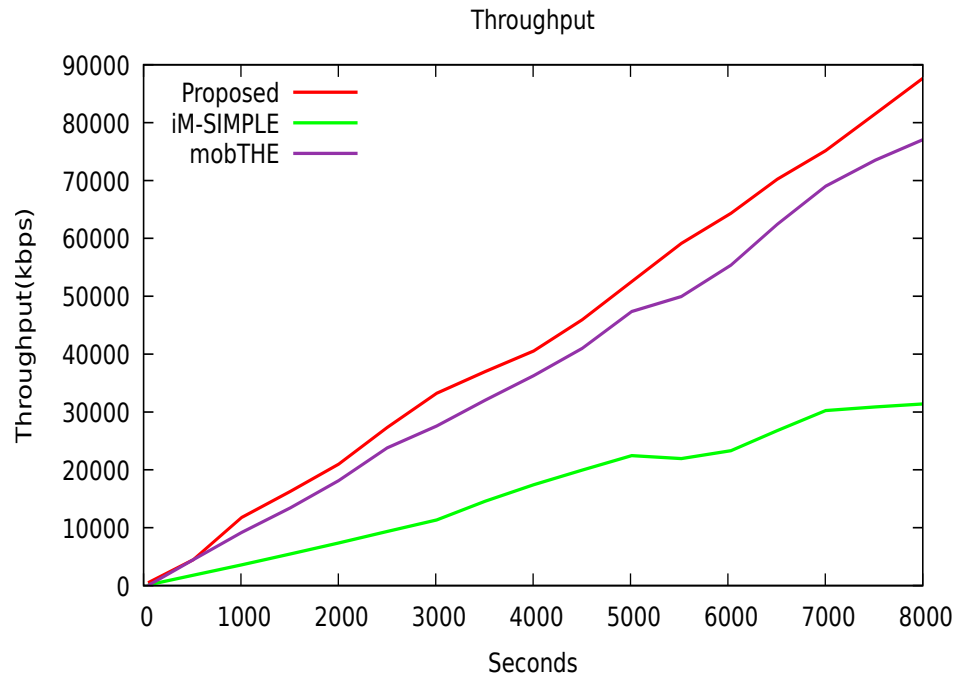

FIGURE 4.5: Comparison of throughput with iM-SIMPLE protocol

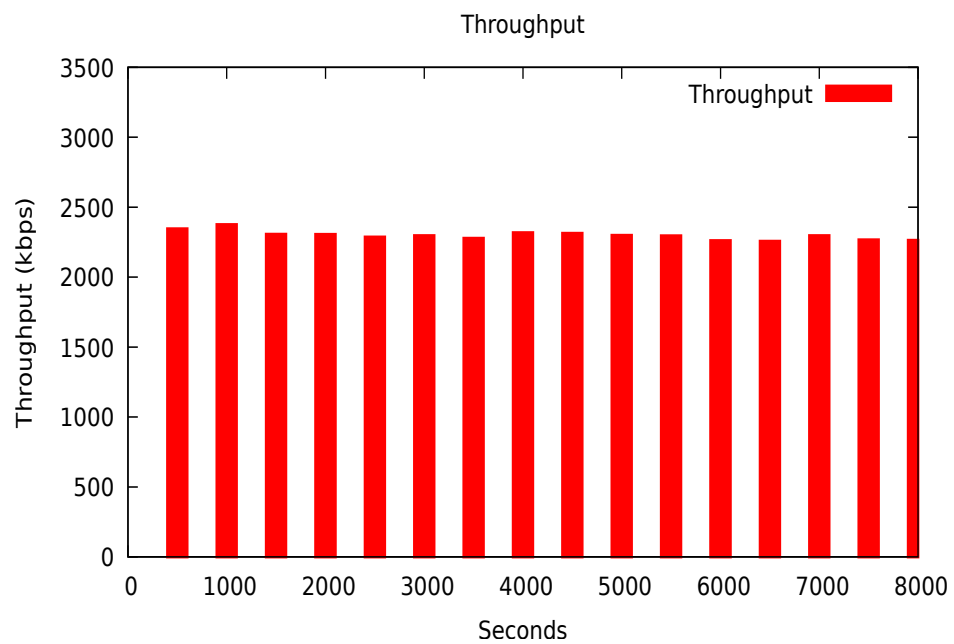

FIGURE 4.6: Comparison of throughput with iM-SIMPLE protocol

#### 4.3.2.5 Packet Drop Rate

Fig 4.7 illustrates the comparison of packet drop rate among proposed approach and iM-SIMPLE protocol. mobTHE does not consider the packet drop rate as the evaluation metric due to which we can't compare it with our proposed approach. Our proposed approach achieves less packet drop rate as compared to iM-SIMPLE protocol. This is attained due to the efficient forwarder node selection via the cost function which considers the energy, temperature, hop count and distance for the selection of forwarder node. Also, it helps the source node to choose most optimal forwarder node among multiple alternate options. It also allows backward forwarding explained in section 3.3 above and choosing any other forwarder node in case when none of the neighbor nodes satisfies the criteria defined for forwarder node selection. It also gets benefits by the use of dual sink nodes which divides the overall network load and increases the network performance. Our proposed approach shows the decreased packet drop by 12.1%.

Packet drop rate is calculated per 100 second. In order to make accurate comparison, we take the same values of x-axis and y-axis given in comparison research paper.

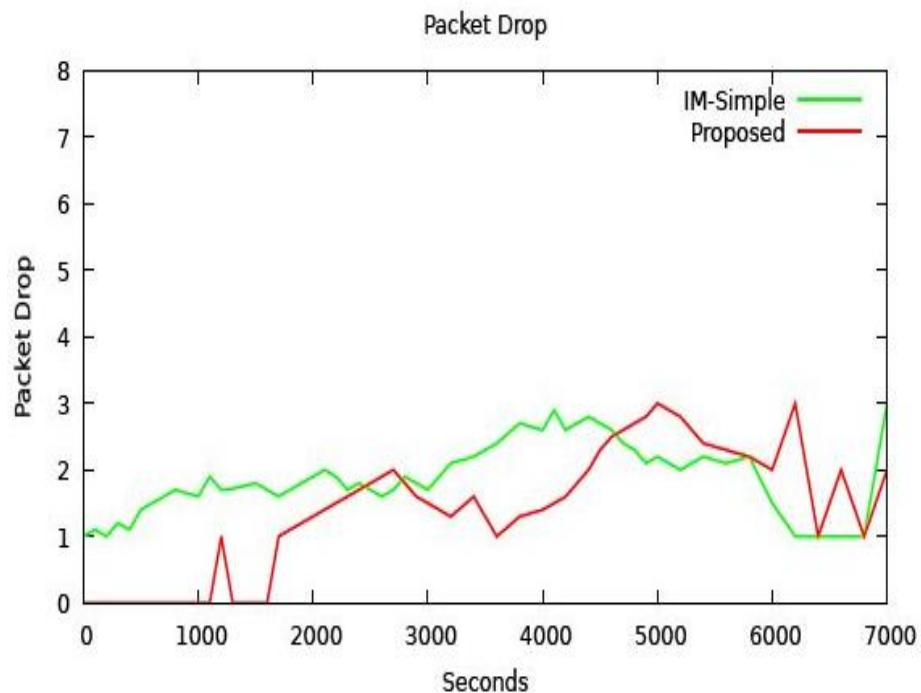

FIGURE 4.7: Comparison of Packet drop with iM-SIMPLE protocol

### 4.3.3 EDGE Optimization for Efficient Bandwidth Utilization

Another aspect of our research is to reduce network bandwidth while the data transmits from the edge node to the cloud. The large amount of data generated by the heterogeneous sensors inflicts many challenges in making the data available to IoT applications. Data reduction is one of the techniques to reduce bandwidth utilization.

It emerged as an efficient solution to apply data reduction on edge. It is really the need to apply some data reduction technique on edge in order to save bandwidth. The bandwidth can be saved by preventing transmission of redundant data and non-critical data.

#### 4.3.3.1 Proposed Methodology

In order to reduce the bandwidth from edge to cloud, we make a simple strategy where we tried to avoid transmission of redundant data, and the data which falls in normal range will be transmitted periodically.

While the data having critical values will be transmitted immediately without delay. This work flow of our strategy is shown in fig 4.8.

Critical and normal ranges of sensors are given in table 4.4 below. On the basis of critical and normal values, we formed a data reduction technique.

In order to distinguish between different types of data coming from different sensors, we defined flags for each sensor node in table below. When this data reaches from sink to edge. Following steps will be performed:

1. Check flag value and then data goes to database in its respective location.
2. When the data received for the first time on the edge, data of all the sensor nodes will be transmitted to cloud.

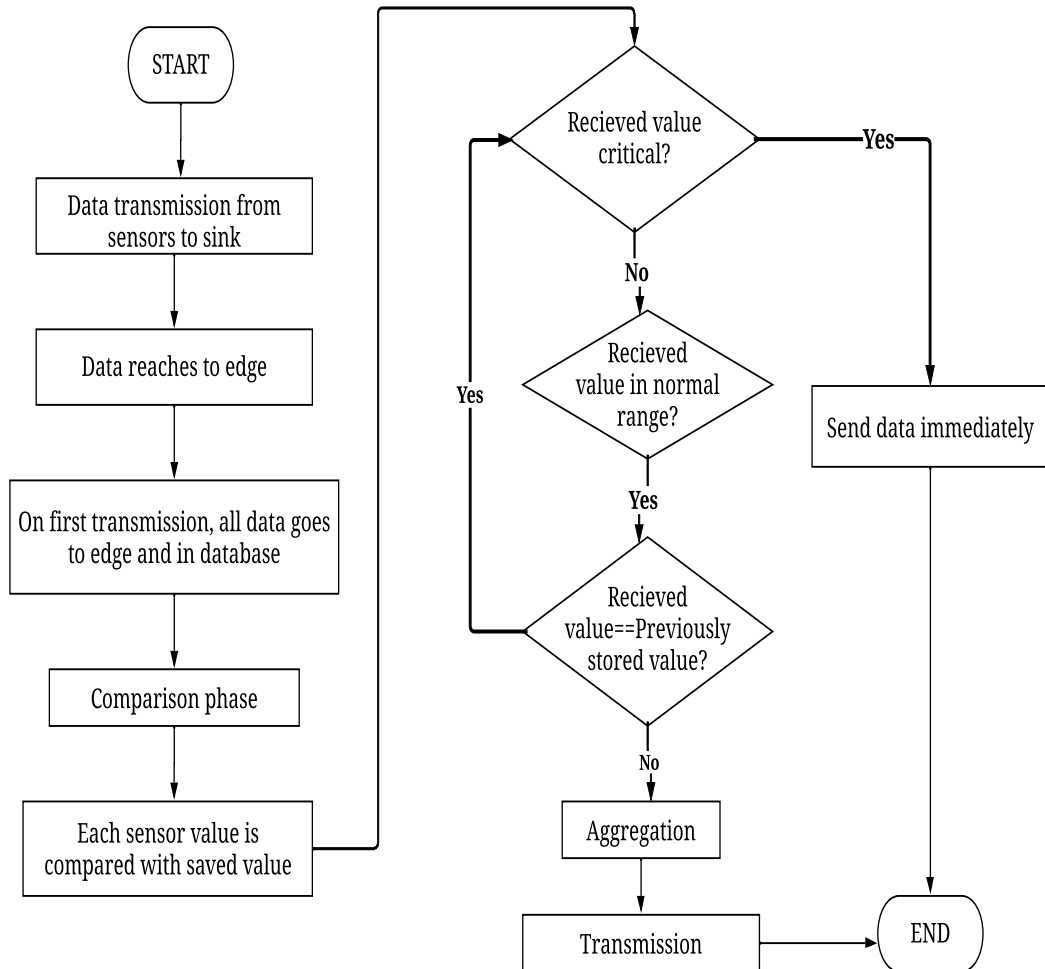

FIGURE 4.8: Flow chart for reducing bandwidth from edge to cloud

3. For subsequent transmission, a comparison is made with previously stored value. The conditions are given below:

a. If the value is same or falls between normal range it will be not be transmitted for the next four consecutive readings. For every fifth value all the previous four values will be aggregated and transmitted at once.

c. If value is between normal ranges then it will not be If the value is critical, it will be transmitted immediately

TABLE 4.4: Normal and threshold values of different sensors

Sensor Nodes	Normal Range	Critical Range
Respiratory rate	<23 per min	>27 per min
Blood pressure	129/84	159/99
Temperature	97 to 99	>102 and 82 <
Glucose	80 to 100	126+
Accelerometer	1g up to $\pm 250g$	>250g and <1g
EEG	8Hz>	7Hz<=
ECG	60 to 100 beats per min	> 100 beats per min
GSR	10K $\Omega$ to 10M $\Omega$	Above 10M $\Omega$
SPO2	80 to 100 mmHg	above 100mmHg and less than 80mmHg
EMG	50 to 60 m/s	<50 or >60m/s
Lactic acid	2.3 mmol/L	< 1.4 or > 4mmol/L

In this way, in case of redundant values or normal range values we can save bandwidth by avoiding unnecessary packet's transmission. One IP packet contains 20-bytes of header information which can be saved by transmitting one packets instead of unnecessary transmission of redundant data.

For example if four consecutive values are same or falls in normal range then we can save  $20 \times 4 = 80$  bytes of data transmission.

TABLE 4.5: Description of flags assigned to sensor nodes

Sensor Nodes	Flag Value
Sensor 1	0000
Sensor 2	0001
Sensor 3	0010
Sensor 4	0011
Sensor 5	0100
Sensor 6	0110
Sensor 7	0111
Sensor 8	1000
Sensor 9	1001
Sensor 10	1010
Sensor 11	1011
Sensor 12	1100
Sensor 13	1101



By applying this data reduction strategy, based on the normal and critical ranges of the different sensor nodes that is given above in table 4.4. We are able to save 29% of bandwidth as depicted in Fig 4.9.

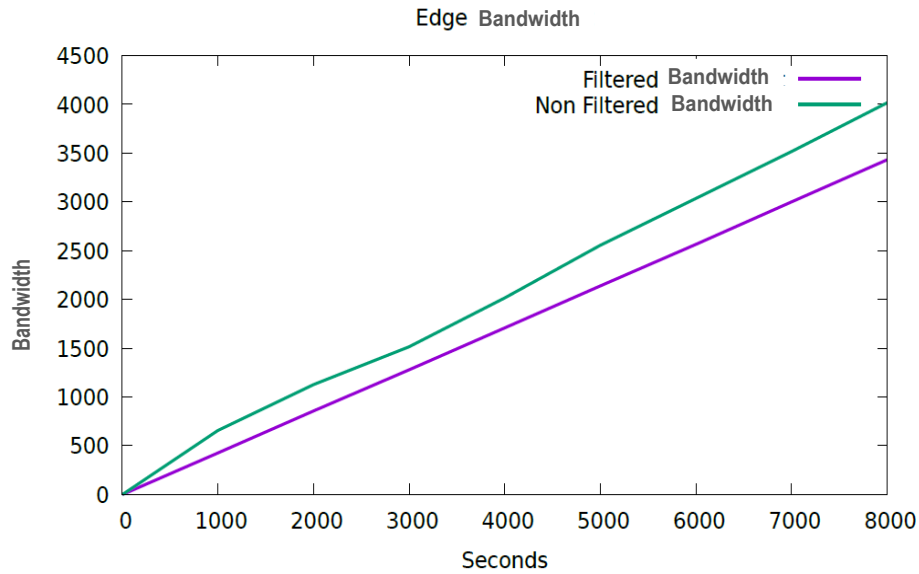

FIGURE 4.9: Comparison between Filtered and Non-Filtered data from egde to cloud

## 4.4 Performance Results

We have compared our proposed technique on the basis of some metrices and improvment in shown in table 4.6 below:

TABLE 4.6: Comparative Results

Sr no.	Metrices	mobTHE	im-SIMPLE
1.	Residual Energy	41.3%	58.7%
2.	Network Life time	7.9%	33.5%
3.	Temperature Rise	23.62%	—
4.	Throughput	17.3%	63.2%
5.	Packet drop rate	—	12.1%

# Chapter 5

## Conclusion and Future Work

### 5.1 Conclusion

The main objective of this thesis is to cater the dis-connectivity of WBAN caused due to mobility of sensor nodes. Also in WBAN, two major features to be considered for steadiness of network are energy preservation and avoiding overheating of sensor nodes. The concern of dis-connectivity is handled by efficient selection of alternate path and keeping in view constraints of WBAN i.e. energy consumption and temperature rise of sensor nodes which may results in network dis-connectivity, increased packet drop, and decreased network life time. Therefore, we used two sink nodes and presented best, average, and worse case scenarios for electing forwarder node based on distance among sensor nodes. It is found in research that more energy is consumed if packet is sent at large distances and more energy consumption results in temperature rise of sensor node which may affect the skin of human body. There are 13 sensor nodes affixed on human body on different positions to estimate the physiological parameter of human body.

Forwarder node is selected on demand, and source node send request to its neighbor nodes for efficient selection based on CF. The proposed CF is comprised of remaining energy, temperature of sensor node, and hop count to sink. Energy and temperature models are used for computing the remaining energy and current

temperature of node respectively. To validate and testify the significance of our proposed mechanism, simulation is performed on the basis of residual energy, network life time, temperature rise, throughput, and packet drop rate. The results produced from the simulations are compared with present techniques mobTHE and iM-SIMPLE protocols. The results shows overall better performance of proposed approach than mobTHE and iM-SIMPLE. The results demonstrated that proposed approach reduces the average sensor node temperature by 23.62% than mobTHE while iM-SIMPLE protocol doesn't consider the temperature rise of the sensor node. It shows increase in network life time by 8.58 % than mobTHE while 52.1% than iM-SIMPEL. Also, it decreases packet drop rate by 32.1% than iM-SIMPLE but packet drop rate is not considered in mobTHE protocol. Moreover, proposed approach improves the throughput by 23.3% than mobTHE while by 25.2% than iM-SIMPLE, whereas increases the residual energy by 38.3% in mobTHE while by 51.7% than iM-SIMPLE.

Following advantages are achieved from suggested techniques are:

- Increased throughput which enables a network to send large amount of data per second hence, decreases latency
- Additionally, increased network life time increases the network stability.
- Decreased packet loss helped to avoid information loss because it real-time transmission and it may contain sensitive data. Hence, increases data availability
- Less temperature rise and more energy saving helped to sustain the network for larger amount of time.

Overhead of our proposed approach is given as:

- The exchange of hello packet to have minimum hop count value.
- On-demand exchange of REQ and REP messages for selecting forwarder node based on Cost Function computation.

- The computation of Cost Function before transmission causes quick energy depletion. Also, it increases delay.
- The comparison for critical and non-critical data for each sensor node increases energy consumption.

## 5.2 Future Work

Currently, WBAN dis-connectivity issue is limited to mobility of arms in six different scenarios while two sink nodes are used at fixed position. In Future, we are planning to focus on two aspects of problem i.e. to consider more postural movement of human body including the mobility of legs and to evaluate the performance more precisely we are planning to apply it to practical application. Furthermore, for increasing the performance of WBAN, we are planning to deploy mobile sink nodes -that is the concept of Wireless Sensor Network- which will further improves the network life time by efficient utilization of energy of sensor nodes.

In current scenario, if none of the neighbor nodes satisfying the criteria defined in cost factor then we are sending data packets backwards for finding alternate path which will consume more time and can cause delay. In future, we will try to implement some other protocol that detects the link failure in advance and helps in converging the data quickly. In present implementation, all type of data – critical and non-critical- is being transmitted to sink nodes by sensor node which may increases network load. In future, we are planning to implement such strategy which will filter out the data in advance and forwards critical data immediately while non-critical data will be sent periodically.

At present, we filter data packets on edge node on the basis of critical data where non-critical data is sent after some interval of time. In future, we are planning to implement some machine learning algorithms which will perform feature extraction on heterogeneous type of data and then analyze the data for future predictions.

# Bibliography

- [1] E. Jovanov, A. Milenkovic, C. Otto, and P. C. De Groen, “A wireless body area network of intelligent motion sensors for computer assisted physical rehabilitation,” *Journal of NeuroEngineering and rehabilitation*, vol. 2, no. 1, pp. 1–10, 2005.
- [2] B. Braem, *Reliable and energy efficient protocols for wireless body area networks*. Universiteit Antwerpen (Belgium), 2011.
- [3] A. Rahim and N. C. Karmakar, “Sensor cooperation in wireless body area network using network coding for sleep apnoea monitoring system,” in *2013 IEEE Eighth International Conference on Intelligent Sensors, Sensor Networks and Information Processing*, pp. 432–436, IEEE, 2013.
- [4] A. Ali and F. A. Khan, “Energy-efficient cluster-based security mechanism for intra-wban and inter-wban communications for healthcare applications,” *EURASIP Journal on Wireless Communications and Networking*, vol. 2013, no. 1, pp. 1–19, 2013.
- [5] T. Wu, F. Wu, J.-M. Redoute, and M. R. Yuce, “An autonomous wireless body area network implementation towards iot connected healthcare applications,” *IEEE access*, vol. 5, pp. 11413–11422, 2017.
- [6] B. Insight, “Bluetooth power classes,” *Bluetooth Insight*, 2008.
- [7] R. Negra, I. Jemili, and A. Belghith, “Wireless body area networks: Applications and technologies,” *Procedia Computer Science*, vol. 83, pp. 1274–1281, 2016.

- 
- [8] I. Al Barazanchi, W. Hashim, A. A. Alkahtani, H. H. Abbas, and H. R. Abdulshaheed, "Overview of wban from literature survey to application implementation," in *2021 8th International Conference on Electrical Engineering, Computer Science and Informatics (EECSI)*, pp. 16–21, IEEE, 2021.
- [9] M. Salayma, A. Al-Dubai, I. Romdhani, and Y. Nasser, "Wireless body area network (wban) a survey on reliability, fault tolerance, and technologies co-existence," *ACM Computing Surveys (CSUR)*, vol. 50, no. 1, pp. 1–38, 2017.
- [10] E. Selem, M. Fatehy, and S. M. Abd El-Kader, "mobthe (mobile temperature heterogeneity energy) aware routing protocol for wban iot health application," *IEEE Access*, vol. 9, pp. 18692–18705, 2021.
- [11] C. Occhiuzzi, C. Vallese, S. Amendola, S. Manzari, and G. Marrocco, "Night-care: A passive rfid system for remote monitoring and control of overnight living environment," *Procedia Computer Science*, vol. 32, pp. 190–197, 2014.
- [12] V. Navya and P. Deepalakshmi, "Threshold-based energy-efficient routing for transmission of critical physiological parameters in a wireless body area network under emergency scenarios," *International Journal of Computers and Applications*, vol. 43, no. 4, pp. 367–376, 2021.
- [13] S. H. Almotiri, M. A. Khan, and M. A. Alghamdi, "Mobile health (m-health) system in the context of iot," in *2016 IEEE 4th international conference on future internet of things and cloud workshops (FiCloudW)*, pp. 39–42, IEEE, 2016.
- [14] H.-W. Kang, C.-M. Kim, and S.-J. Koh, "Iso/ieee 11073-based healthcare services over iot platform using 6lowpan and ble: Architecture and experimentation," in *2016 International Conference on Networking and Network Applications (NaNA)*, pp. 313–318, IEEE, 2016.
- [15] M. A. Alharbi, M. Kolberg, and M. Zeeshan, "Towards improved clustering and routing protocol for wireless sensor networks," *EURASIP Journal on Wireless Communications and Networking*, vol. 2021, no. 1, pp. 1–31, 2021.

- 
- [16] Z. Yang, B. Liang, and W. Ji, "An intelligent end–edge–cloud architecture for visual iot-assisted healthcare systems," *IEEE Internet of Things Journal*, vol. 8, no. 23, pp. 16779–16786, 2021.
- [17] U. M. Malik, M. A. Javed, S. Zeadally, and S. ul Islam, "Energy efficient fog computing for 6g enabled massive iot: Recent trends and future opportunities," *IEEE Internet of Things Journal*, 2021.
- [18] J. Ramkumar and R. Vadivel, "Whale optimization routing protocol for minimizing energy consumption in cognitive radio wireless sensor network," *network*, vol. 1, p. 2, 2021.
- [19] Z. Ullah, I. Ahmed, F. A. Khan, M. Asif, M. Nawaz, T. Ali, M. Khalid, and F. Niaz, "Energy-efficient harvested-aware clustering and cooperative routing protocol for wban (e-harp)," *IEEE Access*, vol. 7, pp. 100036–100050, 2019.
- [20] S. Singh, S. Negi, A. Uniyal, and S. K. Verma, "Modified new-attempt routing protocol for wireless body area network," in *2016 2nd International Conference on Advances in Computing, Communication, & Automation (ICACCA)(Fall)*, pp. 1–5, IEEE, 2016.
- [21] B.-S. Kim, B. Shah, F. Al-Obediat, S. Ullah, K. H. Kim, and K.-I. Kim, "An enhanced mobility and temperature aware routing protocol through multi-criteria decision making method in wireless body area networks," *Applied Sciences*, vol. 8, no. 11, p. 2245, 2018.
- [22] G. Ahmed, D. Mahmood, and S. Islam, "Thermal and energy aware routing in wireless body area networks," *International Journal of Distributed Sensor Networks*, vol. 15, no. 6, p. 1550147719854974, 2019.
- [23] J. Mu, X. Liu, and X. Yi, "Simplified energy-balanced alternative-aware routing algorithm for wireless body area networks," *IEEE Access*, vol. 7, pp. 108295–108303, 2019.

- [24] D.-R. Chen, C.-C. Hsu, M.-Y. Chen, and C.-F. Guo, "A power-aware 2-covered path routing for wireless body area networks with variable transmission ranges," *Journal of Parallel and Distributed Computing*, vol. 118, pp. 379–397, 2018.
- [25] B. Abidi, A. Jilbab, and E. H. Mohamed, "An energy efficiency routing protocol for wireless body area networks," *Journal of medical engineering & technology*, vol. 42, no. 4, pp. 290–297, 2018.
- [26] H. Esmaeili and B. M. Bidgoli, "Emrp: Evolutionary-based multi-hop routing protocol for wireless body area networks," *AEU-international journal of electronics and communications*, vol. 93, pp. 63–74, 2018.
- [27] Y. Peng, X. Wang, L. Guo, Y. Wang, and Q. Deng, "An efficient network coding-based fault-tolerant mechanism in wban for smart healthcare monitoring systems," *Applied Sciences*, vol. 7, no. 8, p. 817, 2017.
- [28] A. Samanta and S. Misra, "Erem: Energy-efficient resource management in body area networks with fault tolerance," in *GLOBECOM 2017-2017 IEEE Global Communications Conference*, pp. 1–6, IEEE, 2017.
- [29] Q. Tang, N. Tummala, S. K. Gupta, and L. Schwiebert, "Tara: thermal-aware routing algorithm for implanted sensor networks," in *International conference on distributed computing in sensor systems*, pp. 206–217, Springer, 2005.
- [30] A. Bag and M. A. Bassiouni, "Hotspot preventing routing algorithm for delay-sensitive applications of in vivo biomedical sensor networks," *Information Fusion*, vol. 9, no. 3, pp. 389–398, 2008.
- [31] D. Takahashi, Y. Xiao, and F. Hu, "Ltrt: Least total-route temperature routing for embedded biomedical sensor networks," in *IEEE GLOBECOM 2007-IEEE Global Telecommunications Conference*, pp. 641–645, IEEE, 2007.
- [32] N. Kaur and S. Singh, "Optimized cost effective and energy efficient routing protocol for wireless body area networks," *Ad Hoc Networks*, vol. 61, pp. 65–84, 2017.



- [33] F. Hourai, M. Tabandeh, M. Jahed, and S. Moradi, "A thermal-aware shortest hop routing algorithm for in vivo biomedical sensor networks," in *2009 Sixth International Conference on Information Technology: New Generations*, pp. 1612–1613, IEEE, 2009.
- [34] A. Bag and M. A. Bassiouni, "Routing algorithm for network of homogeneous and id-less biomedical sensor nodes (rain)," in *2008 IEEE Sensors Applications Symposium*, pp. 68–73, IEEE, 2008.
- [35] N. Javaid, Z. Abbas, M. Fareed, Z. A. Khan, and N. Alrajeh, "M-attempt: A new energy-efficient routing protocol for wireless body area sensor networks," *Procedia Computer Science*, vol. 19, pp. 224–231, 2013.
- [36] N. Javaid, A. Ahmad, Q. Nadeem, M. Imran, and N. Haider, "im-simple: improved stable increased-throughput multi-hop link efficient routing protocol for wireless body area networks," *Computers in Human Behavior*, vol. 51, pp. 1003–1011, 2015.
- [37] U. F. Abbasi, A. Awang, and N. H. Hamid, "A cross-layer opportunistic mac/routing protocol to improve reliability in wban," in *The 20th Asia-Pacific Conference on Communication (APCC2014)*, pp. 36–41, IEEE, 2014.
- [38] G. R. Tsouri, A. Prieto, and N. Argade, "On increasing network lifetime in body area networks using global routing with energy consumption balancing," *Sensors*, vol. 12, no. 10, pp. 13088–13108, 2012.
- [39] Y. Qu, G. Zheng, H. Wu, B. Ji, and H. Ma, "An energy-efficient routing protocol for reliable data transmission in wireless body area networks," *Sensors*, vol. 19, no. 19, p. 4238, 2019.
- [40] Z. Ullah, I. Ahmed, K. Razzaq, M. K. Naseer, and N. Ahmed, "Dscb: Dual sink approach using clustering in body area network," *Peer-to-Peer Networking and Applications*, vol. 12, no. 2, pp. 357–370, 2019.

- 
- [41] O. Ahmed, F. Ren, A. Hawbani, and Y. Al-Sharabi, "Energy optimized congestion control-based temperature aware routing algorithm for software defined wireless body area networks," *IEEE Access*, vol. 8, pp. 41085–41099, 2020.
- [42] S. Abbasian Dehkordi, K. Farajzadeh, J. Rezazadeh, R. Farahbakhsh, K. Sandrasegaran, and M. Abbasian Dehkordi, "A survey on data aggregation techniques in iot sensor networks," *Wireless Networks*, vol. 26, no. 2, pp. 1243–1263, 2020.
- [43] A. M. Ghosh and K. Grolinger, "Deep learning: Edge-cloud data analytics for iot," in *2019 IEEE Canadian Conference of Electrical and Computer Engineering (CCECE)*, pp. 1–7, IEEE, 2019.
- [44] S. Oueida, Y. Kotb, M. Aloqaily, Y. Jararweh, and T. Baker, "An edge computing based smart healthcare framework for resource management," *Sensors*, vol. 18, no. 12, p. 4307, 2018.
- [45] W. M. El-Sayed, H. M. El-Bakry, and S. M. El-Sayed, "Integrated data reduction model in wireless sensor networks," *Applied Computing and Informatics*, 2020.
- [46] M. Mohamed, W. Wu, and M. Moniri, "Data reduction methods for wireless smart sensors in monitoring water distribution systems," *Procedia Engineering*, vol. 70, pp. 1166–1172, 2014.
- [47] G. Muhammad, M. F. Alhamid, M. Alsulaiman, and B. Gupta, "Edge computing with cloud for voice disorder assessment and treatment," *IEEE Communications Magazine*, vol. 56, no. 4, pp. 60–65, 2018.
- [48] A. M. Rahmani, T. N. Gia, B. Negash, A. Anzanpour, I. Azimi, M. Jiang, and P. Liljeberg, "Exploiting smart e-health gateways at the edge of healthcare internet-of-things: A fog computing approach," *Future Generation Computer Systems*, vol. 78, pp. 641–658, 2018.

- [49] C. Salim, *Data Reduction based energy-efficient approaches for secure priority-based managed wireless video sensor networks*. PhD thesis, Bourgogne Franche-Comté, 2018.
- [50] W. S. Ling, O. B. Yaik, and L. S. Yue, “A novel data reduction technique with fault-tolerance for internet-of-things,” in *Proceedings of the Second International Conference on Internet of things, Data and Cloud Computing*, pp. 1–7, 2017.
- [51] Q. Nadeem, N. Javaid, S. N. Mohammad, M. Khan, S. Sarfraz, and M. Gull, “Simple: Stable increased-throughput multi-hop protocol for link efficiency in wireless body area networks,” in *2013 eighth international conference on broadband and wireless computing, communication and applications*, pp. 221–226, IEEE, 2013.
- [52] S. Ahmed, N. Javaid, S. Yousaf, A. Ahmad, M. M. Sandhu, M. Imran, Z. A. Khan, and N. Alrajeh, “Co-laeeba: Cooperative link aware and energy efficient protocol for wireless body area networks,” *Computers in Human Behavior*, vol. 51, pp. 1205–1215, 2015.
- [53] A. Tauqir, N. Javaid, S. Akram, A. Rao, and S. N. Mohammad, “Distance aware relaying energy-efficient: Dare to monitor patients in multi-hop body area sensor networks,” in *2013 Eighth International Conference on Broadband and Wireless Computing, Communication and Applications*, pp. 206–213, IEEE, 2013.
- [54] M. Javed, G. Ahmed, D. Mahmood, M. Raza, K. Ali, and M. Ur-Rehman, “Taeo-a thermal aware & energy optimized routing protocol for wireless body area networks,” *Sensors*, vol. 19, no. 15, p. 3275, 2019.
- [55] F. Jamil, M. A. Iqbal, R. Amin, and D. Kim, “Adaptive thermal-aware routing protocol for wireless body area network,” *Electronics*, vol. 8, no. 1, p. 47, 2019.

- 
- [56] O. Smail and A. Kerrar, “Energy-aware and stable routing protocol for hospital wireless body area networks,” *J. Inf. Sci. Eng.*, vol. 37, no. 1, pp. 1–13, 2021.
- [57] Z. Shahbazi and Y.-C. Byun, “Towards a secure thermal-energy aware routing protocol in wireless body area network based on blockchain technology,” *Sensors*, vol. 20, no. 12, p. 3604, 2020.
- [58] A. K. Sagar, S. Singh, and A. Kumar, “Energy-aware wban for health monitoring using critical data routing (cdr),” *Wireless Personal Communications*, vol. 112, no. 1, pp. 273–302, 2020.
- [59] O. Ahmed, M. Hu, and F. Ren, “Peditara: Priority-based energy efficient, delay and temperature aware routing algorithm using multi-objective genetic chaotic spider monkey optimization for critical data transmission in wbans,” *Electronics*, vol. 11, no. 1, p. 68, 2021.
- [60] S. Memon, J. Wang, A. R. Bhangwar, S. M. Fati, A. Rehman, T. Xu, and L. Zhang, “Temperature and reliability-aware routing protocol for wireless body area networks,” *IEEE Access*, vol. 9, pp. 140413–140423, 2021.
- [61] S. Javaid, Z. Wu, Z. Hamid, S. Zeadally, and H. Fahim, “Temperature-aware routing protocol for intrabody nanonetworks,” *Journal of Network and Computer Applications*, vol. 183, p. 103057, 2021.
- [62] K. N. Qureshi, S. Din, G. Jeon, and F. Piccialli, “Link quality and energy utilization based preferable next hop selection routing for wireless body area networks,” *Computer Communications*, vol. 149, pp. 382–392, 2020.
- [63] W. B. Heinzelman, A. P. Chandrakasan, and H. Balakrishnan, “An application-specific protocol architecture for wireless microsensor networks,” *IEEE Transactions on wireless communications*, vol. 1, no. 4, pp. 660–670, 2002.